

# Saint Clair Place

Neighborhood Revitalization Plan

October 2009

Property Address:

---

Builder Name and Contact Information:

---

---

---

---

## Housing Rehabilitation + Construction Pattern Book

Background Information  
Sustainability Standards  
Rehabilitation Standards  
New Construction Standards  
Landscape Standards

## BUILDERS CHECKLIST

### SUSTAINABILITY STANDARDS

- Does the home meet EPA Energy Star and Indoor airPLUS standards?
- Does the home have a radon system installed?
- Does the project investigate water efficiency measures?
- Does the project effectively manage your construction waste stream?
- Does the project implement on-site stormwater management techniques?

### REHABILITATION STANDARDS

- If there have been previous improper changes to the house, have they been corrected?
- Has the original exterior form been preserved during rehabilitation?
- Do new additions follow the standards of this document?
- Do doors, windows, gutters, siding and trim follow the standards of this document?
- If there are unique and special interior features, have they been incorporated into the rehab?

### NEW CONSTRUCTION STANDARDS

- Are new houses built consistent to existing setbacks?
- Are there "primary elevations" facing each street and open space?
- If you have a garage or carriage house, do they follow the standards of this document?
- Does the project follow massing standards for the body + foundations?
- Does the project follow massing standards for wings, dormers, chimneys and porches?
- If the user needs it, have you followed the accessibility standards of this document?
- Does the project's porch meet the standards of this document?
- Do your eaves + gables meet the standards of this document?
- Were composition standards for windows, doors, and vents followed?
- Do windows and doors meet the requirements of this document?
- Do flues, downspouts, and exterior lights meet the standards of this document?
- Do the siding, trim, and color choices meet the standards of this document?

### LANDSCAPE STANDARDS

- Were only plants from the approved plant palette used for this project?
- Does the front yard follow the standards of this document?
- Do all fences and walls meet the standards of this document?

## CONTACT INFORMATION

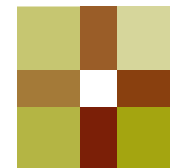

Indy-east Asset  
Development

I•AD

#### PROJECT CONTACT:

**Katy Brett, Executive Director**  
Indy-east Asset Development (IAD)

*kbrett@enn.org*  
*(317) 808-2364*

#### PATTERN BOOK CONSULTANTS:

EDEN Collaborative  
[www.edencollaborative.com](http://www.edencollaborative.com)

A2SO4 Architecture  
[www.a2s04.com](http://www.a2s04.com)

**EXECUTIVE SUMMARY**

**1.0 BACKGROUND INFORMATION**

1.1 PROJECT LOCATION ..... 4  
 1.2 OVERVIEW OF RECENT PLANNING ..... 5  
 1.3 HOW TO USE THIS DOCUMENT ..... 6  
 1.4 RELEVANT REGULATIONS ..... 7

**2.0 SUSTAINABILITY STANDARDS**

2.1 INTRODUCTION ..... 9  
 2.2 GREEN BUILDING ..... 10  
     2.2.1 ENERGY STAR QUALIFIED HOMES ..... 10  
     2.2.2 INDOOR AIR QUALITY ..... 10  
     2.2.3 WATER CONSERVATION ..... 10  
     2.2.4 DECONSTRUCTION + CONSTRUCTION WASTE ..... 10  
     2.2.5 ALTERNATIVE ENERGY ..... 10  
 2.3 STORMWATER MANAGEMENT + HARDSCAPE ..... 11  
     2.3.1 DISCONNECT DOWNSPOUTS ..... 11  
     2.3.2 RAIN BARRELS ..... 11  
     2.3.3 RAIN GARDENS + BIOSWALES ..... 11  
     2.3.4 HARDSCAPE MATERIALS ..... 11

**3.0 REHABILITATION STANDARDS**

3.1 INTRODUCTION ..... 13  
 3.2 EXISTING HOUSING TYPES ..... 14  
     3.2.1 HOUSING TYPES ..... 14  
     3.2.2 IMPORTANT FEATURES ..... 14  
 3.3 REPAIR OF PREVIOUS IMPROPER CHANGES ..... 15  
     3.3.1 NOTES ON REHABILITATION ..... 15  
     3.3.2 IMPROPER CHANGES ..... 15  
 3.4 PRESERVING LAYOUT AND FORM ..... 17  
     3.4.1 SITE LAYOUT ..... 17  
     3.4.2 REHABILITATION - PRESERVING FORM ..... 17  
 3.5 NEW ADDITIONS TO EXISTING HOMES ..... 18  
     3.5.1 ADDITIONS, WINGS + DORMERS ..... 18  
     3.5.2 NEW PORCHES + CHIMNEYS ..... 18  
 3.6 DOORS, WINDOWS, + GUTTERS ..... 19  
     3.6.1 EXTERIOR DOORS ..... 19  
     3.6.2 WINDOWS ..... 19  
     3.6.3 GUTTERS ..... 19  
 3.7 SIDING + TRIM ..... 20  
     3.7.1 BRICK + MASONRY ..... 20  
     3.7.2 CLAPBOARD + VINYL ..... 20  
     3.7.3 TRIM ..... 20  
 3.8 IMPORTANT INTERIOR FEATURES ..... 21  
     3.8.1 INTERIOR FEATURES ..... 21

**4.0 NEW CONSTRUCTION STANDARDS**

4.1 INTRODUCTION ..... 23  
 4.2 SITE LAYOUT ..... 24  
     4.2.1 LOT SIZES ..... 24  
     4.2.2 SETBACKS ..... 25  
     4.2.3 TYPOLOGIES ..... 26  
     4.2.4 ORIENTATION ..... 26  
     4.2.5 MID-BLOCK HOUSING ..... 27  
     4.2.6 CORNER LOT HOUSING ..... 27  
     4.2.7 HOUSING NEXT TO OPEN SPACE ..... 27  
     4.2.8 GARAGES + CARRIAGE HOUSES ..... 28  
 4.3 FORM ..... 29  
     4.3.1 INTRODUCTION ..... 29  
     4.3.2 MASSING - MAIN BODY + FOUNDATIONS ..... 29  
     4.3.3 MASSING - WINGS, DORMERS, CHIMNEYS + PORCHES ..... 30  
     4.3.4 ACCESSIBILITY MEASURES ..... 31  
     4.3.5 PORCH STANDARDS ..... 32  
     4.3.6 EAVE + GABLE STANDARDS ..... 33  
 4.4 WINDOWS, DOORS + VENTS ..... 34  
     4.4.1 COMPOSITION OF WALLS ..... 34  
     4.4.2 WINDOW STANDARDS ..... 35  
     4.4.3 DOOR STANDARDS ..... 35  
 4.5 EXPOSED FUNCTIONAL ITEMS ..... 36  
     4.5.1 FLUES ..... 36  
     4.5.2 DOWNSPOUTS ..... 36  
     4.5.3 EXTERIOR LIGHTS ..... 36  
 4.6 SURFACE DETAILS ..... 37  
     4.6.1 SIDING ..... 37  
     4.6.2 TRIM ..... 37  
     4.6.3 COLORS ..... 37

**5.0 LANDSCAPE STANDARDS**

5.1 INTRODUCTION ..... 39  
 5.2 LANDSCAPE STANDARDS ..... 40  
     5.2.1 PLANTING STANDARDS ..... 40  
     5.2.2 ACCEPTABLE PLANTS ..... 40  
     5.2.3 FENCING STANDARDS ..... 41

## 1.1 PROJECT LOCATION

The Saint Clair Place Neighborhood - Near Eastside - Indianapolis, Indiana

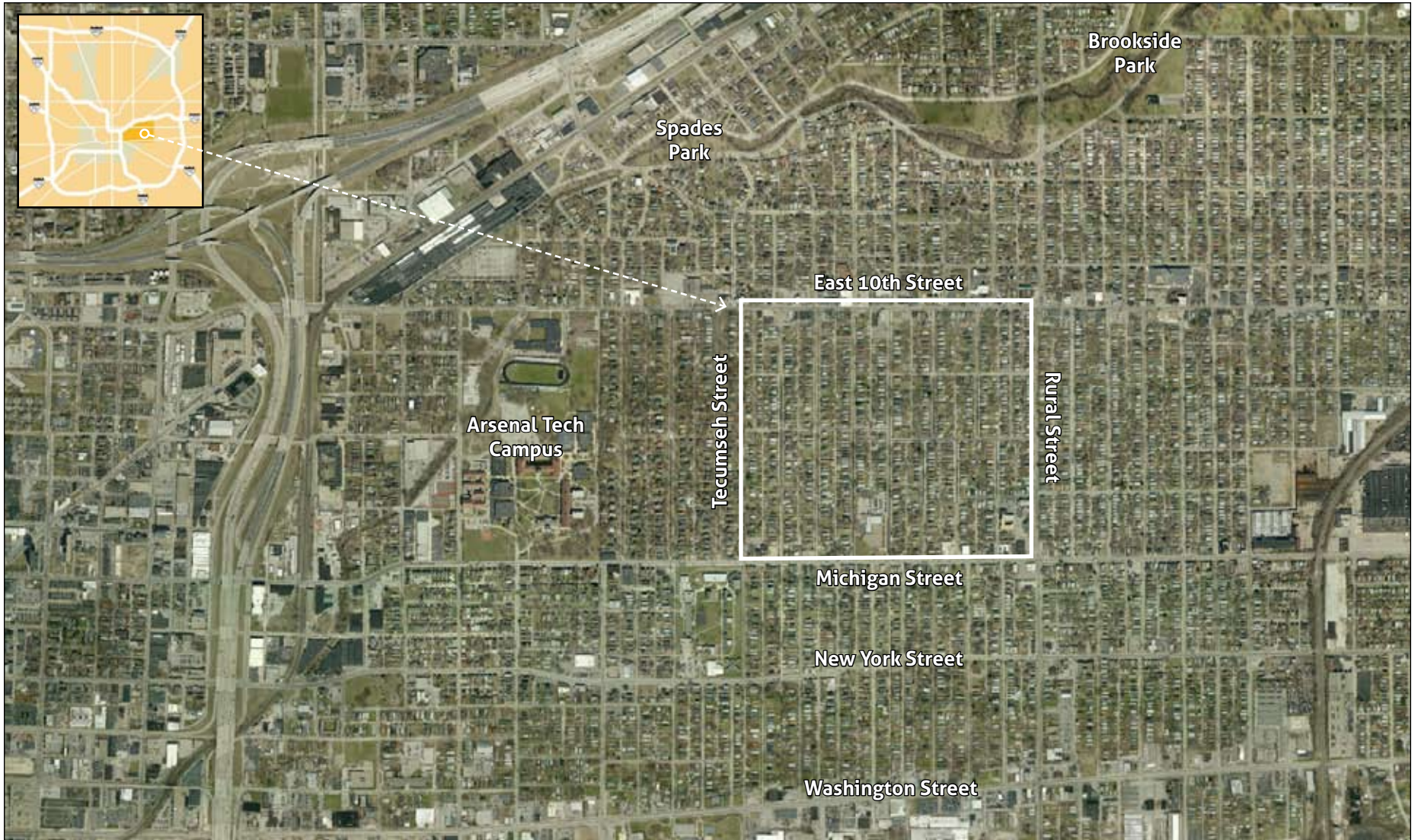

The Saint Clair Place neighborhood is located on the Near Eastside of Indianapolis. The neighborhood is bounded by 10th Street, Rural Street, Michigan Street and Tecumseh Street. Tecumseh Street is the boundary between Saint Clair Place and another well-known Indianapolis neighborhood, Woodruff Place.

### BACKGROUND INFORMATION

The revitalization of the Saint Clair Place neighborhood will transform a distressed 155 acre neighborhood currently dominated by over 150 vacant and abandoned homes, 90 vacant lots, and a 35% homeownership rate into a diverse, thriving, mixed-income community. The rehabilitation of existing homes and the development of new housing opportunities are crucial components of a broader plan to restore the Saint Clair Place neighborhood to good health. Near Eastside residents and stakeholders have a long history of measuring neighborhood well-being in “quality of life” terms, and in June 2005 convened the Near Eastside Collaborative Taskforce to holistically address these issues. The Taskforce was the driver behind the City’s creation of a pair of important regulatory and financing tools in 2006; the Near Eastside Redevelopment Area and Housing Tax Increment Financing district (HoTIF). The momentum of this intensive neighborhood engagement subsequently led to the selection of the Near Eastside as one of the demonstration areas for the Great Indy Neighborhoods Initiative (GINI) in 2007. The resulting Near Eastside Quality of Life Plan (available at [www.indyeast.org](http://www.indyeast.org)) was developed over the course of a year by more than 400 residents and stakeholders. This comprehensive plan charges Indy-east Asset Development (I-AD), a not-for-profit community development corporation (CDC), with implementing many of the recommendations related to housing issues. It was through this comprehensive, collaborative process that the St. Clair Place neighborhood was selected as the initial focus for a large-scale neighborhood revitalization effort.

In late 2008, I-AD began working with Saint Clair Place residents and a team of planning and development professionals to craft a comprehensive Revitalization Plan for the neighborhood. Through an intensive four-month process, a long-term vision for the neighborhood emerged, dubbed the Saint Clair Place Game Plan. The Game Plan suggests, among other things, that the neighborhood should be “green” and recommends reserving space for a series of parks and farms linked by pedestrian trails. The Game Plan also outlines ideas for incorporating sustainable stormwater infrastructure in refurbished streets and alleyways and identifies opportunities to enhance the character of East 10th Street and build on the strong foundation of the Boner Center. These strategies are aimed at encouraging new residents to buy homes in the near-term while also simultaneously creating long-term assets that benefit existing residents.

In order to complement and build on these broad revitalization goals, this Pattern Book was created to guide housing development in Saint Clair Place. Specifically, the principles outlined here are a direct reflection of the values expressed by residents and stakeholders during the community planning process. These guidelines and requirements are designed to ensure that housing development in Saint Clair Place will be sensitive to existing neighborhood fabric, architecturally appropriate, and built to the highest quality standards, including current green building standards. As such, this guide will be a valuable tool for both rehabilitation professionals and builders working in Saint Clair Place.



Vision Sketch - The 10th Street Corridor



Vision Sketch - Jefferson Avenue Rain Gardens



Vision Sketch - Urban Farms

## 1.3 HOW TO USE THIS DOCUMENT

### ADDRESSING PUBLIC CONCERNS

This pattern book attempts to respond to these top public desires the planning team heard during the planning process:

- Build the Legacy of a Strong, Green Neighborhood for the Future.
- Create stability, better maintenance, and high-quality homes.

#### Respond to the Site

- Respond to the variety of lot types and site conditions.
- Limit, to the extent possible, sewage problems and maintenance needs.

#### Respond to the Market

- Create opportunities and houses for new residents.
- Create opportunities for people with a variety of incomes.
- Create an environment that encourages existing residents to stay.
- Ensure that redevelopment does not adversely affect existing owners' property values.
- Ensure that requirements are feasible for homeowners who take part in the homeowner repair program.

#### Respond to Neighborhood's History

- Work with the established neighborhood layout and scale.
- Be creative to ensure the best use of recent and coming improvements and new amenities, so that they provide the best possible service to residents.

### WHAT IS A PATTERN BOOK?

A pattern book is a set of design guidelines that offers recommendations and requirements for properties that undergo building activities within the neighborhood. There is a long history of pattern books being utilized to guide the way houses are built to ensure that neighborhoods and houses are successful and durable.

### THE INTENTION OF THE PATTERN BOOK

Unfortunately in Saint Clair Place, home rehabilitation over the years has often been done in an inappropriate manner. This has helped contribute to the decline of the Saint Clair Place neighborhood. The intention is that this pattern book helps to showcase techniques to reverse this situation.

This pattern book is intended to ensure that the neighborhood is built to the standards that have been determined during the planning process. The following principles have guided this Pattern Book's creation:

- Reinforce the existing fabric. A major project goal is to rehabilitate as many vacant homes as feasible to celebrate their architectural contribution to the neighborhood fabric.
- Construct compatible new homes on vacant lots. These new homes should complement the existing housing stock in its form and massing, but not necessarily style.
- Promote a Green Neighborhood for the future. These steps are intended to reduce energy and infrastructure costs and mitigate sewage and stormwater issues.

### HOW TO USE THE PATTERN BOOK

1. First, make sure to refer to the Sustainability Standards section. All homes must be certified by a RESNET-accredited provider to meet the Energy Star for New Homes standard, including the complementary Indoor airPLUS and Advanced Lighting Package specifications. Water conservation measures and alternative energy systems are also encouraged, as well as various on-site stormwater management techniques. Additionally, builders and renovators should consider how to effectively manage their construction waste streams.
2. Second, refer to the section that relates to your project type. Are you doing a Rehabilitation – a renovation and/or addition to existing home? Or, are you doing New Construction – building on empty lots?

For either section, there will be requirements for multiple items that range from the broadest issues, such as the overall form, to details such as siding requirements, doors, and windows. Each of these are requirements that a housing project must meet.

3. Third, refer to the section of Landscape Standards. Make sure to comply with each of the standards listed.

### REVIEW PROCESS

This Pattern Book will establish the basis on which I-AD evaluates proposals submitted by contractors working in the Saint Clair Place neighborhood. Although I-AD expects the review and evaluation process to evolve over time, this Pattern Book is designed to serve as a relevant guide over the course of this long-term neighborhood revitalization. As such, this Pattern Book presents both guiding principles as well as specific items that successful proposals must address. Proposals will be reviewed and evaluated based on compatibility with the overall guidelines, as well as understanding of and approach to the more nuanced design and construction details that are presented here.

Of particular note are the requirements outlined in the Sustainability Standards section. Rather than establishing proprietary green building requirements, I-AD has adopted the Energy Star for Homes standard for all new and rehabbed homes. Energy Star for Homes is a well established program designed to help builders deliver housing that saves energy and protects the health of occupants. Because the program requirements are periodically updated, Energy Star for Homes will continue to serve as a relevant baseline "green" certification well into the future. It is important that each proposal specifically outline strategies for achieving the Energy Star program certifications described in the Sustainability Standards section. In addition to a wealth of information available at [www.energystar.gov](http://www.energystar.gov), I-AD will develop technical assistance resources for builders that are not familiar with the Energy Star for Homes program.

Since I-AD is serving as the developer of the Saint Clair Place Revitalization Plan, the I-AD Project Team will designate an initial representative body to review and evaluate proposals and specifications. Builders, rehabbers, and developers submitting proposals for housing projects in the Saint Clair Place neighborhood will have the opportunity to solicit and receive feedback should their particular proposal not be selected. This Pattern Book is not meant to be restrictive, but rather serve as a guide that will help builders to develop proposals that are contextually sensitive while maintaining the highest construction standards. As part of IAD's long-term neighborhood revitalization strategy, the review and evaluation policies, procedures, and processes may change. As I-AD works to catalyze positive change and restore neighborhood health, new and different mechanisms may be instituted as required to foster and sustain beneficial private investment.

### EXCEPTIONS FOR CONTEMPORARY DESIGN

These standards are not intended to squelch innovation or contemporary design. Contemporary design is encouraged. For cases where the standards of this pattern book prevent a contemporary gesture or style decision, those cases can be brought for review. These standards are intended as a set of minimum requirements and suggestions for basic infill housing.

### BUILDING ACTIVITY REGULATIONS

- This Pattern Book will be used to evaluate properties developed by I-AD.
- Residents receiving Homeowner Repair Grants will also be held to these standards.
- This will help establish a strong framework to successfully revitalize the Saint Clair Place community in a well-designed manner consistent with the neighborhood's priorities.

### PUBLIC ZONING CONTROL

It is important to note that this pattern book is subordinate to Indianapolis Zoning Codes and Building Code. Information about Zoning included in the pattern book does not function in zoning's place and each project will require coordination with the I-AD and the City of Indianapolis. I-AD intends to closely work with the City of Indianapolis Department of Metropolitan Development (DMD) to obtain variances in an expedient manner.

Currently, there are a few zoning regulations which will inhibit building activities within Saint Clair Place as they relate to the desires of this Pattern Book. Saint Clair Place is generally regulated under the D-5 Zoning Classification. Within that classification, there are several requirements (shown below) that conflict with the desires of this document. However, there are general exceptions within the D-5 Zoning Classification that allow for existing setbacks in the neighborhood to supersede those prescribed in zoning language.

The requirement that each lot have a minimum of 65% of the parcel dedicated to open space does not have a listed exception and will, in most cases, require a variance. For reference, a summarized list of setbacks and restrictions from the D-5 zoning classification is listed below:

- Minimum Lot Area: 5000 sft for single-family + 9000 sft for a double
- Minimum Lot Width: 50 feet for single-family + and 90 feet for a double
- Minimum Street Frontage: 25 feet
- Minimum Rear Yard: 20 feet
- Minimum Side Yard: 4 ft per side + 10 feet in total
- Minimum Open Space: 65%
- Minimum Main Floor Area: 900 sft
- Minimum Second Floor Area: 660 sft
- Two Off-Street Parking Spaces are required per single-family
- For multi-family: Must have administrator approval to remove trees over 3" caliper (or replace with = caliper). Must have a landscape plan approved. Also has lighting + maintenance requirements.
- Should unique multi-family forms be desired, it is likely that a rezoning request will be needed.
- 
- The Indianapolis Zoning Ordinance can be found online at:  
<http://www.indy.gov/EGOV/CITY/DMD/PLANNING/ZONING/Pages/municode.aspx>

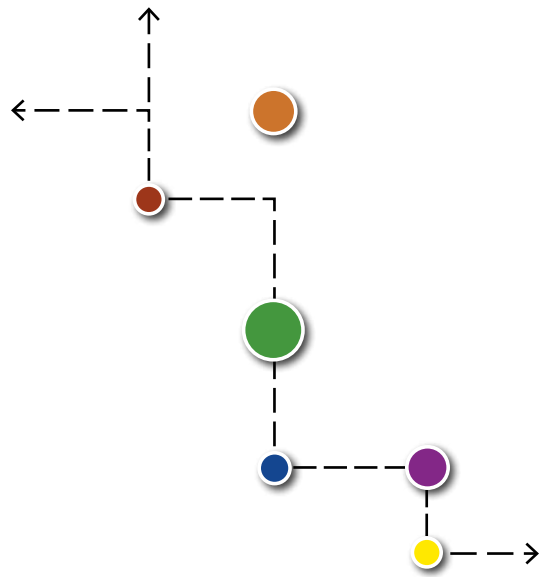



# Saint Clair Place

Housing Construction and Rehabilitation

Pattern Book

## Chapter 2.0 Sustainability Standards

### 2.1 INTRODUCTION

These standards focus on reducing energy consumption and ultimately reducing the cost of utilities for homeowners in the neighborhood. Additionally



## 2.2 GREEN BUILDING



### 2.2.1 ENERGY STAR QUALIFIED HOMES

- All homes must be certified to meet the EPA Energy Star standard for New Homes, including the Advanced Lighting Package. For more information visit [http://www.energystar.gov/index.cfm?c=new\\_homes.hm\\_index](http://www.energystar.gov/index.cfm?c=new_homes.hm_index).

### 2.2.2 INDOOR AIR QUALITY

- All homes must be certified to meet the EPA Indoor airPLUS standard, including the installation of a radon mitigation system. For more information visit [http://www.epa.gov/indoorairplus/construction\\_specifications.html](http://www.epa.gov/indoorairplus/construction_specifications.html).
- The EPA classifies Marion County as a Zone 1 high radon risk area. For more information visit the EPA's Indiana radon website at <http://www.epa.gov/radon/states/indiana.html>.

### 2.2.3 WATER CONSERVATION

- The EPA WaterSense New Homes program provides a sensible framework for builders that want to implement water conservation measures. The Draft Water-Efficient Single-Family Specification may be found at <http://www.epa.gov/WaterSense/specs/homes.htm>.

### 2.2.4 DECONSTRUCTION + CONSTRUCTION WASTE

- Deconstruction, or the systematic disassembly of a structure for the purpose of salvaging or recycling building materials, is a viable alternative to outright demolition and disposal.
- Homes may be 'soft-stripped' to glean architectural salvage items such as doors, plumbing fixtures, flooring, trim, and lighting fixtures.
- There are several nascent deconstruction efforts underway in Indianapolis that support salvage, selective demolition, and material segregation and recycling activities.

### 2.2.5 ALTERNATIVE ENERGY

- Installation of alternative energy systems is encouraged.
- Solar photovoltaic (PV) systems generate electricity and help to reduce energy bills.
- Solar thermal systems for heating domestic hot water can be very cost-effective when considering the payback period.



Energy Star qualified homes utilize efficient HVAC systems, like this SEER-14 air conditioner.



Energy Star qualified homes are tested for air-tightness. This is tested using a blower door.



A radon system contributes to healthy indoor air. The EPA recommends radon systems for Marion County.



Insulation, especially in the attic, is an important energy conservation measure.



Low-flow plumbing fixtures, such as this dual-flush toilet, can reduce water use.



Solar energy can be harnessed to heat water or produce electricity.

## 2.3 STORMWATER MANAGEMENT + HARDSCAPE

### 2.3.1 DISCONNECT DOWNSPOUTS

- Downspouts and sump pumps are often connected directly to the combined sanitary/storm sewer system. Disconnecting downspouts and sump pumps helps to mitigate CSO (Combined Sewer Overflow) events.
- See <http://www.indy.gov/eGov/City/DPW/Environment/CleanStream/HelpResidents/Connect/Pages/home.aspx> for more information on the City of Indianapolis DPW Correct Connect program.

### 2.3.2 RAIN BARRELS

- Rain barrels are encouraged and can be attached to the main downspout of the housing unit.
- Rain barrels may include an overflow valve that releases excess water for percolation purposes and for surface watering of native ground plantings. Rain barrel overflow must be directed away from foundations.
- Special care should be taken when directing gutter outflow that plants in line with drainage are not prone to water logging or negatively affected by inundation.

### 2.3.3 RAIN GARDENS + BIOSWALES

- Depending on the contours of each individual lot, bioswales of limited depth may be desired to direct runoff from downspouts and yards toward the rights-of-way.
- Positive flow should be maintained, though percolation is encouraged via the use of very minimal slopes, such as a one-percent grade.

### 2.3.4 HARDSCAPE MATERIALS

- Drives, pads, garage aprons, patios and other hard surfaces of rear yards should be of a high-Albedo surface to reduce their contribution to the heat-island effect.
- Attention should be paid to patio surfaces without cover that a "blinding" effect is not created by overly white surfaces reflecting too much sunlight onto users.
- Permeable paving is encouraged, including pervious concrete and asphalt and reinforced grass paving.
- Recycled materials are preferred, given equal performance and durability.
- Site materials such as concrete, asphalt and stone can be found from previous demolition sources..
- It is encouraged that waste materials from the construction process be considered for future uses.



Disconnecting downspouts reduces the load on the combined sewer system.



Rain barrels can be used to capture rainwater; this one is also a planter.



Rain gardens capture stormwater before it enters the combined sewer system.



Porous paving materials help manage stormwater by reducing runoff and allowing infiltration.

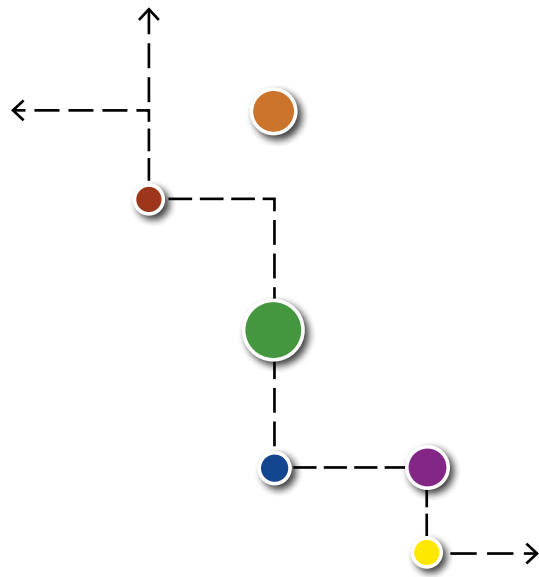

# Saint Clair Place

Housing Construction and Rehabilitation

Pattern Book

## Chapter 3.0 Rehabilitation Standards

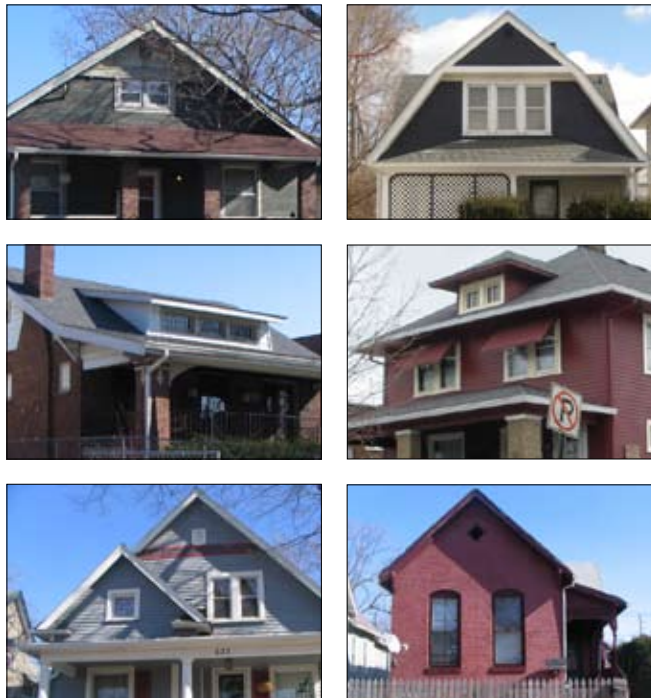

### 3.1 INTRODUCTION

The planning process identified rehabilitation as the preferred method to deliver housing in Saint Clair Place because of the quantity of existing homes that are high in character. It is desired that homes with good character and good “bones” will be considered for rehabilitation.

The rehabilitation standards in this pattern book focus on preserving the character of existing homes, while allowing interior adjustments for current lifestyles. The focus is mainly on exteriors.

The standards apply not only to those homes being rehabilitated and resold by IAD, but also to existing homeowners who utilize homeowner repair dollars.

## 3.2 EXISTING HOUSING TYPES

### 3.2.1 HOUSING TYPES

During the planning process, several housing types were identified as the most prevalent within Saint Clair Place. They are shown here so that builders are aware of the mix of housing types in the neighborhood. The most prevalent types are:

- Bungalow
- Craftsman
- Foursquare (often as doubles)
- Dutch Colonial
- Folk Victorian

NOTE: There is considerable variation within each of the types found in the neighborhood. The sketches to the right are just a general example.

NOTE: While these five types represent the many of the homes in the neighborhood, there are many other types present in Saint Clair Place. It is hoped that all original housing that is in good condition and has good character will be rehabilitated, regardless of whether it fits within these five styles.



- Bungalow Characteristics:
- Low-pitched roofs
  - Characterized by simple living
  - Porch may or may not be beneath main roof extension



- Dutch Colonial Characteristics:
- Gambrel Roof
  - Wide front porches
  - Often have off-center front doors



- Craftsman Characteristics:
- Low-pitched roofs with deep overhangs
  - Porch beneath main roof extension
  - Exposed rafters and knee brackets



- Foursquare Characteristics:
- Simple box shape at 2-1/2 stories
  - Front porch covers the whole front
  - Hipped roof and dormer or front gable with attic vents or windows



- Folk Victorian Characteristics:
- Front Gabled with front porches
  - Share many characteristics with craftsman, but have higher-pitched roofs.

### 3.2.2 IMPORTANT FEATURES

While the entire house is important for existing homes being rehabilitated in Saint Clair Place, there are certain items, especially on the primary elevation of homes, that are critical to the neighborhood's character that can be found on desirable examples in existing houses.

- FRONT PORCHES  
The original housing stock of Saint Clair Place put a high priority on front porches. Porches were thought of as an extension of the house and a way for neighbors to interact with each other - fostering a sense of community. Front porches place a high priority on high-quality porch columns and short walls. Many of these are built in brick with stone caps.
- HIGH QUALITY AND QUANTITY OF WINDOWS  
In most cases, there are very few areas of walls that do not have windows. There are also windows present in all doors and in foundations. This was to allow a large amount of natural light and ventilation. Original windows are very attractive and should be preserved when possible.
- FRONT DOORS THAT WELCOME  
The original homes in Saint Clair Place place a high priority on the quality, attractiveness and welcoming nature of front doors. These doors had windows and attractive hardware. Many items, such as porch lights, mailboxes, and house numbers are attractive and placed near the front door.

### 3.3 REPAIR OF PREVIOUS IMPROPER CHANGES

#### 3.3.1 NOTES ON REHABILITATION

Existing homes generally conform to an established style of design and rehabilitation is asked to conform with the characteristics of that style. These homes often have craftsmanship and materials that may not be available or affordable in today's economy. Therefore, it is beneficial to maintain and reuse as much as possible.

#### 3.3.2 IMPROPER CHANGES

Many houses have been improperly changed over time resulting in the loss of certain characteristics, which were highly important to the integrity of the appearance. These should be corrected when possible as indicated below.

##### ROOFS - PITCH, GABLES + EAVES

- If a roof form or pitch has been previously altered from its original condition, it should be rebuilt to be consistent with the original intent of the home.
- If eaves and gables that once extended past the body of the house have been removed to save money during re-roofing projects, they should be replaced or corrected.

##### DORMERS + ATTIC VENTS or WINDOWS

- Original dormers, as well as attic vents or windows, are critical to the character of homes. Many homes that once had these features have had them removed during re-roofing or re-siding activity in an effort to save money.
- For homes where the loss of a dormers and attic vents or windows has negatively effected the house, they should be replaced as originally built.

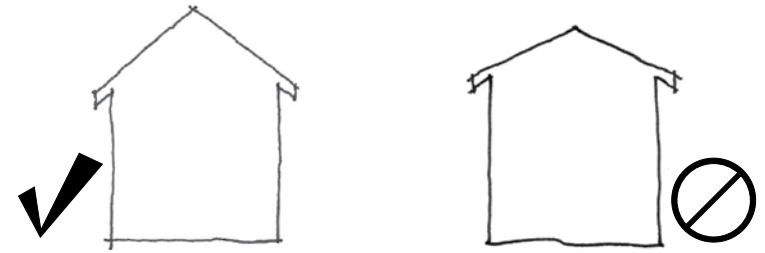

If a roof form or pitch has been previously altered from its original condition, it should be rebuilt to be consistent with the original intent of the home.

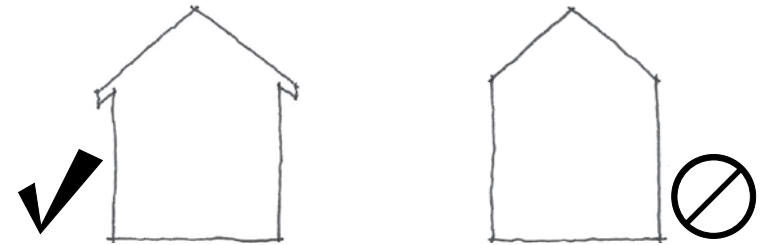

If eaves and gables that once extended past the body of the house have been removed to save money during re-roofing projects, they should be replaced or corrected

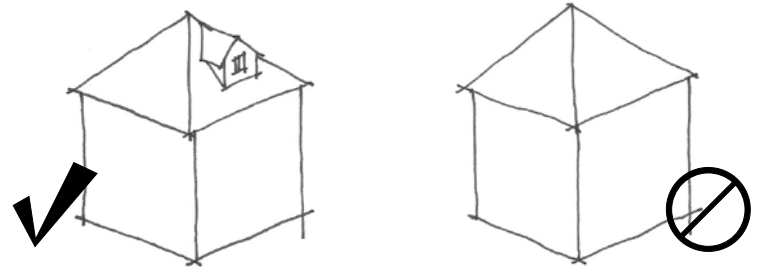

For homes where the loss of a dormers and attic vents or windows has negatively effected the house, they should be replaced as originally built



For homes where the loss of a dormers and attic vents or windows has negatively effected the house, they should be replaced as originally built

### 3.3 REPAIRING PREVIOUS IMPROPER CHANGES

#### 3.3.2 IMPROPER CHANGES - CONTINUED

##### PORCHES

- Porches are critical to the character of homes. While most original homes maintain their porches, many have had original columns and posts replaced with inconsistent materials, such as thin metal rails and undersized basic wood columns and wooden pickets.
- During rehabilitation, where porches have been made inconsistent with their original appearance, they should be replaced to fit their original context.

##### ORIGINAL DOORS

- Original housing often had very high quality exterior doors made of attractive and durable hardwood. These have often been replaced with doors of lower quality to save cost or to offer the perception of enhanced security.
- Original doors can be made as secure as modern materials by incorporating double-barrel locks.
- Where original doors have been replaced with incompatible new ones, they should be replaced with doors that fit with the context. Older doors can be found locally and restored to work in these situations.
- Restored and replacement doors must fit their original openings. For example, no 80" height doors will be permitted on larger original openings.
- Windows and transoms over doors that have previously existed, but sided over should be reopened to their original size and character.

##### ORIGINAL WINDOWS

- Original housing often had very attractive windows. Many have been replaced with windows of lower quality or incorrect size to save cost or to offer enhanced energy efficiency or the perception of security.
- Original windows can be made as energy efficient and secure as modern windows by adding modern glass into the sashes. Many companies can perform this locally.
- Windows needing repair should be retained and repaired when possible.
- Where original windows have replaced with incompatible new ones, they should be replaced with windows that fit with the context. If no original windows exist, the existing windows can be compared with new construction standards for compatibility.
- Any previously altered sized windows should be returned to the original size of the rough opening.

##### ORIGINAL TRIM

- Many homes have had trim removed or covered over during re-siding projects on original homes. In these cases, original trim should be uncovered or trim that fits the original context should be added.



If a porch has been removed, it should be replaced.



Metal porch railing does not match the character of the existing homes.



This door is not compatible with the character of the neighborhood.



This original door opening is larger than the current door. Doors must match original openings.



Windows should fit into the original rough openings and match existing character.



Original windows are attractive and can be made energy efficient.



This trim is flush and offers no depth, while the siding "j" channels are too bold.



Original trim should be maintained or uncovered where possible.



## 3.4 PRESERVING LAYOUT AND FORM

### 3.4.1 SITE LAYOUT

Site layout is already established for existing homes under consideration for rehabilitation. However, there are some instances to consider effects on site layout.

#### □ PLACEMENT OF NEW ADDITIONS

Additions should be made to the side or rear of the home and not project closer to the street than the original face of the home.

Additions should not infringe upon existing side-yard setbacks that were established by the original construction, unless there is ample space in the side yard due to a house being narrow or an unusually wide lot.

#### □ LOCATION ON CORNER LOT OR NEXT TO OPEN SPACE

Original homes are typically well articulated on side walls and will be attractive on corner lots or next to open space once they are rehabilitated.

However, in the event that one of these side walls is not attractive or does not address the side street or open space well, it may add character by adding features such as a wing with a gable, an extension of the front porch that wraps to the side, a side door with access from the front or the street, or more windows. These steps are not required for rehabilitations.

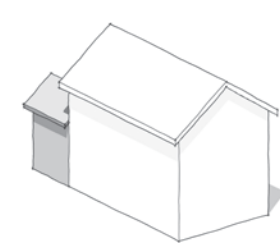

New additions should be made to the side or rear of the home.

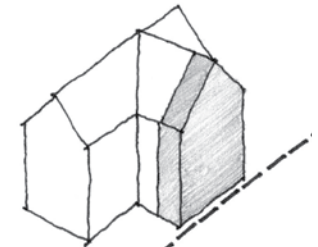

ADDITION - NON COMPLIANT. This wing is shown extended too close to the property line.

### 3.4.2 REHABILITATION - PRESERVING FORM

During rehabilitation, it is important to preserve the main formal characteristics of existing homes.

- Existing roofs should not change in pitch or form during renovations. Original eaves and gable extensions should be maintained. If these are in poor condition, repairs should be made with like-sized materials.
- Roofing Material may change, but should be consistent throughout the house and garage.
- The existing form of the body of the house should remain the dominant form during any renovation activity.
- No wings, dormers, porches or chimneys should be removed during rehabilitation. If these items are in poor condition, they should be repaired so that all walls are flush and stable.
- If foundation walls are being repaired or replaced, any new materials should be similar to the original in size, color, and texture. All grout should match in appearance as well.

### 3.4.3 GARAGES + CARRIAGE HOUSES

**CARRIAGE HOUSE:** The term carriage house was originally used to refer to the area behind a home where horse-drawn carriages were stored. These have often been turned into accessory dwelling units and the name is now used for dwelling units above garages. Other terms such as coach house, mother-in-law quarters, and granny flat refer to these also.

- If a garage exists on a lot of a rehabilitation project, it should be rehabilitated as feasible. All materials, siding, trim, door and window requirements that apply to main structures also apply to garages.
- Garages should be built on lots of rehabilitations - for both corner lots and lots that face open space.
- Foundations of new construction accessory units should match the primary unit in the height of the exposed foundation and in material.
- The roof pitch must either match the main structure or have a minimum 6:12 pitch.
- For new carriage houses, greater leniency is permitted in design vocabulary to allow for interesting decks, offices, and other features that will not negatively affect the block as viewed from the street.
- Carriage houses are not addressed in zoning. A variance will be necessary.
- Sheds, above ground pools, and other accessory structures are generally discouraged, unless they contribute to the appeal of the neighborhood by servicing food production or composting.



Existing homes on corner lots or next to open space are not required to add wings or dormers.



Changes can be made to address side walls in the event they are not attractive or do not address the street or open space well. These can include adding wings, dormers or porches.

## 3.5 NEW ADDITIONS TO EXISTING HOMES

### 3.5.1 ADDITIONS, WINGS + DORMERS

#### MAJOR OR LARGE ADDITIONS

- New additions must not overpower the original structure as the primary focus of the house.
- Major additions should be to the rear of the home. If they must project higher than the existing roof line, the new roof must match the pitch and detailing of the existing roof, trim, and main body.
- Foundations for additions must be exposed and match the existing foundation in material and floor height.

#### NEW WINGS

- Added wings must be smaller in height and scale than the original main body of the house. This allows for additional square footage without disrupting the main structure.
- Additions should use a roof form and pitch that is consistent or complementary with the existing structure.
- The siding material and trim size should either match or be complementary to the main body of the house.
- Eaves and Gable Extensions on wings should be of a consistent depth and appearance (including materials) with existing eaves.
- The floor height and materials of the new foundation should match the existing foundation. Wings which project more than three feet from the home must have foundations.

#### NEW DORMERS

- Adding dormers can be a way to add space to second stories or when converting attic space to an additional floor.
- New dormers must be consistent with existing dormers on the house. If no dormers currently exist, the new dormer must be either consistent or complementary to the existing roof and form and materials of the house.
- Eaves and Gable Extensions on dormers will likely be less deep than those of the main body, but their proportion must fit with the context of the house. They should not be over- or under-sized.
- All new dormers must contain either a vent or window that is appropriately scaled.

### 3.5.2 NEW PORCHES + CHIMNEYS

#### PORCHES

- If a home is missing a porch - a porch must be added. The new porch should be complementary to the main structure of the home and must match the floor height. Porch additions must conform to the standards for porches given in the "New Construction" section.
- Porches must not be removed unless they are an incompatible type added long after the original construction. If porches are added onto, the additions must match the existing porch in all aspects of scale and material.

#### CHIMNEYS + FLUES

- Existing external chimneys must not be removed. Exceptions will be made if the chimney is to the rear of the home and is not an important visual feature that can be seen from any street or open space.
- If a new chimney is added, it must be masonry (brick) or stone. If it is exterior, it must have its own foundation, so that it does not appear to float from the exterior wall.
- "Boxed-in" and sided exterior vertical chases that house B-vent chimneys are not permitted.
- PVC flues should be to the rear of houses.

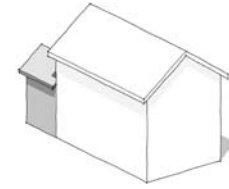

New additions must not overpower the original structure as the primary focus of the house.

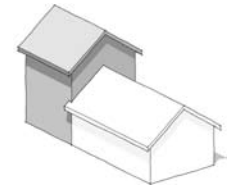

ADDITION - NON COMPLIANT. The addition to the rear of this home overpowers the original structure.

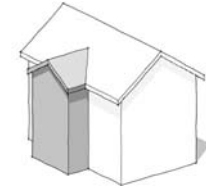

Added wings must be smaller in height and scale than the original main body of the house.

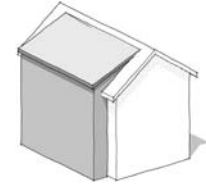

WINGS - NON COMPLIANT. The form and scale is appropriate for dormers, but this wing disrupts the house's form.



New Dormers must be either consistent or complementary to the existing roof form, such as these gable dormers.

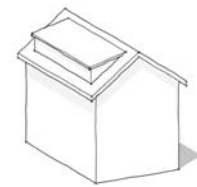

New Dormers must be either consistent or complementary to the existing roof form, such as this widened shed dormer.



Existing external chimneys must not be removed.



"Boxed-in" and sided exterior vertical chases that house B-vent chimneys are not permitted.

### 3.6.1 REPLACEMENT EXTERIOR DOORS

- ❑ Replacement doors and new doors on additions need to match the original character of the home.
- ❑ It is encouraged that when new doors are required, older wood doors that are in good condition be used, especially on the front. These can be found locally.
- ❑ Doors should be metal or wood.
- ❑ New doors should not be overly ornate or include caming or glass shapes or patterns that do not fit with the original intent of the home.
- ❑ Storm doors and screen doors are acceptable but should complement the existing door and overall design. These should be highly transparent.

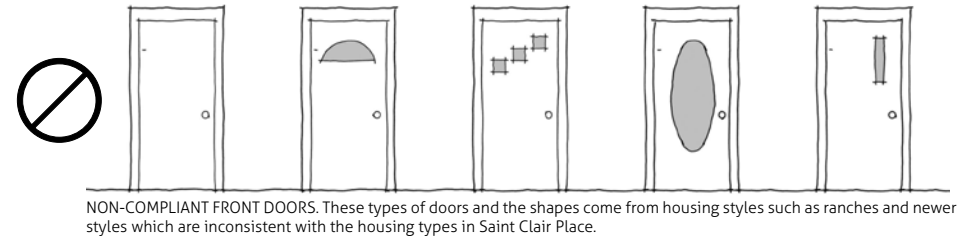
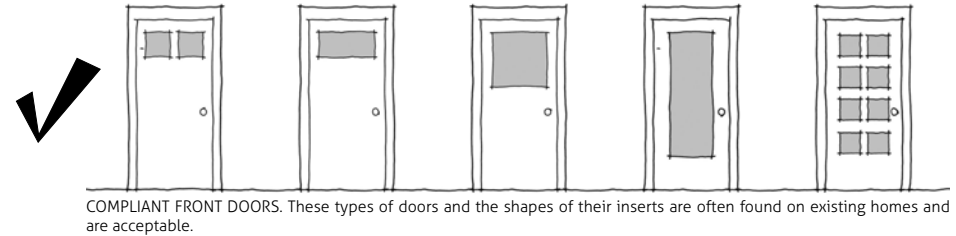

### 3.6.2 REPLACEMENT WINDOWS

- ❑ Storm windows may be added to existing windows.
- ❑ Replacement windows should be consistent with original openings.
- ❑ Replacement window styles should be consistent with what was original to the home (i.e. double hung windows should be replaced with new double hung windows) Stile and rail widths and sight lines must match existing original windows.

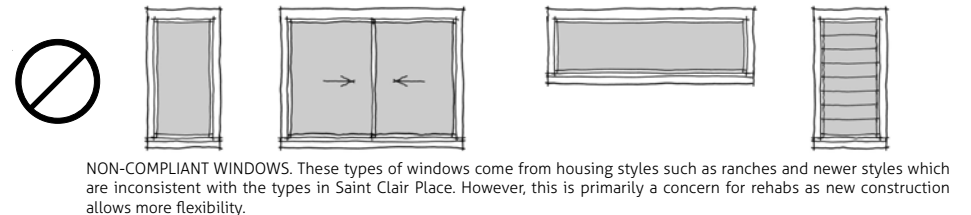
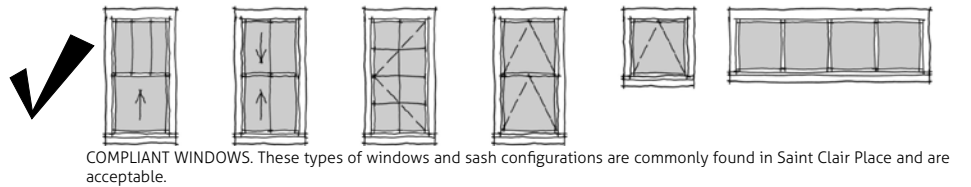

### 3.6.3 GUTTERS

- ❑ The existing layout of gutters should be kept, if positive flow is attainable.
- ❑ Downspouts should be oriented away from the foundation and ensure positive drainage.
- ❑ Existing gutters, or those that are added, should match either the body or trim of home in color. Exceptions will be made for existing copper or ornamental guttering.
- ❑ Downspouts that currently are connected to the home's sewer discharge pipe should be disconnected and forced to drain into lawns and open space.



Downspouts should be placed to the sides, not at the front.



This downspout should not be placed in front of the porch column.

## 3.7 SIDING AND TRIM

### 3.7.1 BRICK AND MASONRY

- Any new or replacement materials must closely match existing materials in terms of color, size and texture.
- Houses that were originally made of wood siding must not be re-faced with brick. This is not true to the original intent for the house.
- Any re-pointing mortar must closely match the existing house in composition, such as profile, material, color and texture.
- Sandblasting or strong chemicals should not be used on masonry.
- Unpainted masonry should not be painted. Previously painted masonry may be left painted or repainted.
- No cement, plaster, stucco, or other coating should be applied over brick that has previously not been coated.



Good Existing Brick House



Houses that were originally made of wood siding must not be re-faced with brick.

### 3.7.2 CLAPBOARD AND VINYL

- Existing siding, if original to the home, should be maintained whenever possible.
- When replacing siding on portions of the house, new siding must match the material, color, pattern and style of what is in place.
- If a house must be fully re-sided, materials should be consistent with the original materials of the home. For example, if the original home used scalloped siding, new siding must be scalloped. If a synthetic lap siding is used (i.e. cement hardboard, vinyl) the widths of the exposure must be consistent with the original siding.
- New siding must be of a smooth finish, unless it is to match an existing material that is designed to have texture, such as cedar shakes.
- The use of vinyl siding during rehabilitation is highly discouraged. However, if a house is re-sided in vinyl, no exposed j-channels will be permitted and vinyl must conform to standards given in the "New Construction" section.



Good Existing Siding

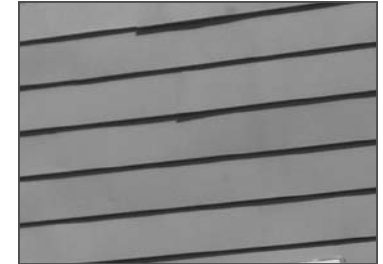

This vinyl siding is irregular, with wave patterns shown.

### 3.7.3 TRIM

- Original detailing should not be removed if in servicable condition, but any later added detailing which is inconsistent with the style of the home should be removed.
- It is encouraged that original exterior details that have been lost over the years be replaced and/or restored.
- New and/or replacement trim must match the material, color, pattern, size and style of existing or original trim.
- Houses should not be over-decorated with extensive additional detailing, unless that detailing was a significant feature of the original home, as is found on Victorian, Craftsman and other styles.



Good Existing Trim



The trim on this home has been removed and replaced with very small pieces as well as covering over the porch.

### 3.8.1 INTERIOR FEATURES

Interiors are not the focus of this pattern book. This is to allow for interior rehabilitation to allow for a modern layout and lifestyle. There are, however, several suggestions which may help add to the character of a home's interior without negatively affecting the ability of an interior to meet modern demands.

#### INTERIOR BUILT-IN WOOD CABINETS AND NOOKS

- Many original houses have very high quality interior built-in features made of attractive and durable hardwood. These are often too difficult and expensive to provide in modern housing.
- It is suggested that interior built-in cabinets and nooks be retained where possible and worked into new interiors. These can be unique selling points and help retain the history of the home's craftsmanship.

#### INTERIOR DOORS

- Original housing often has very high quality interior doors made of attractive and durable hardwood. Where these types of doors remain, it is suggested that they be retained and worked into new interior layouts.
- These doors can provide character to the home.

#### ORIGINAL HARDWOOD FLOORS

- Original housing often has very nice wood floors that are very attractive. These have often been covered over with carpet.
- It is encouraged that hardwood floors be refinished where costs are not prohibitive.

#### ORIGINAL FIREPLACES AND MANTLES

- Original housing often has very attractive fireplaces and mantles. These have often been covered over or left in poor maintenance as they have been replaced by modern heating systems.
- It is encouraged that fireplaces be retained and refinished where costs are not prohibitive and where interior layouts allow.

#### ORIGINAL STAIRWELLS, RAILS + WINDERS

- Original stairwells, rails and winders are significant features that are hard to find in new construction. Where these items can be worked into interior layouts, it is suggested that they be rehabilitated or retained.

#### ORIGINAL CASING + TRIM

- Where these items can be worked into interior layouts, it is suggested that they be rehabilitated or retained.

**NOTE: The incorporation of interior features is suggestive, not required. This is to allow builders ultimate flexibility to provide for modern lifestyles. However, the features mentioned above can be highly beneficial to retaining a sense of history and character inside of the home.**



Good Built-ins should be retained.



Good Interior Doors should be retained.



Good Hardwood Floors should be retained.



Good fireplaces should be retained.

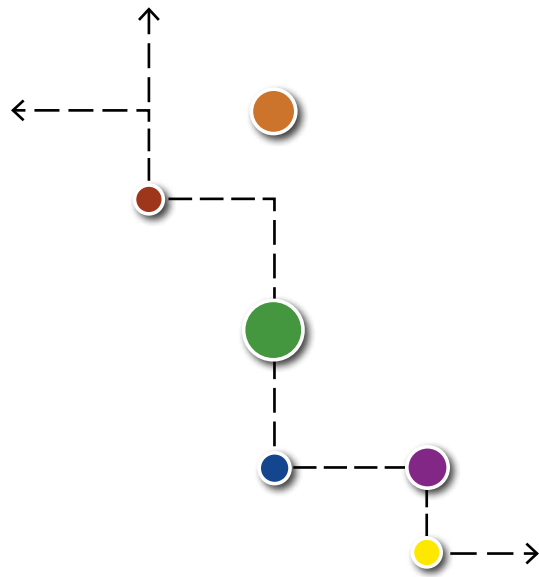

# Saint Clair Place

Housing Construction and Rehabilitation

Pattern Book

## Chapter 4.0 New Construction Standards

### 4.1 INTRODUCTION

Standards for new home construction do not focus on architectural styles. They specify requirements for characteristics of site layout, form, massing, composition, detailing, and sustainability measures.



## 4.2 SITE LAYOUT

### 4.2.1 LOT SIZES

The lots in Saint Clair Place have a variety of sizes. The depth of lots may have some bearing on how builders choose to provide housing on these lots. The general size groups of lots is shown in the key below.

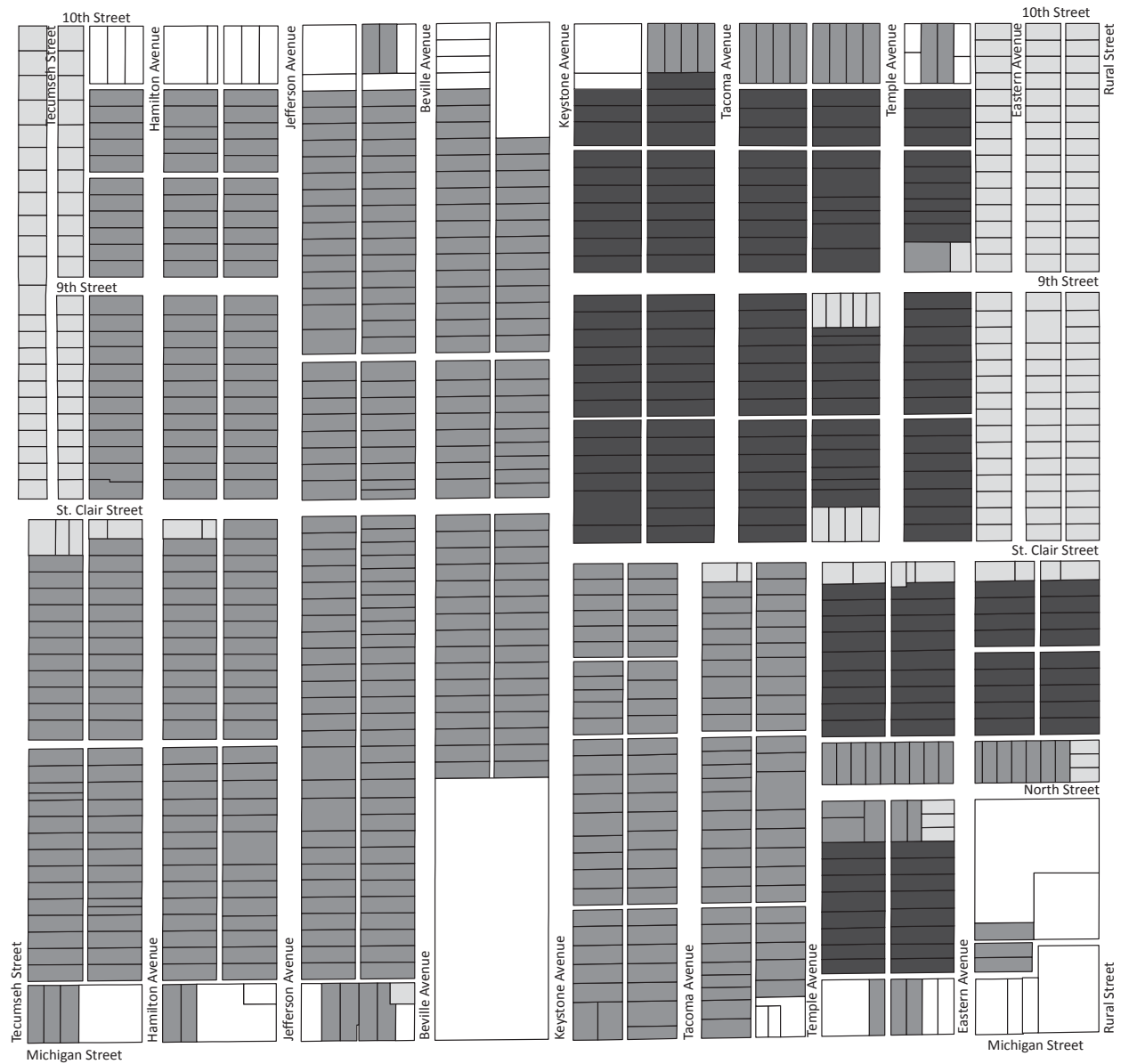
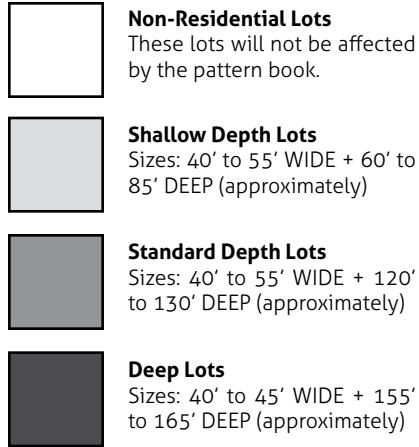



**4.2.1 LOT SIZES**

Different lot sizes offer different opportunities and challenges. The builder can decide how to capitalize on opportunities or solve challenges below.

**Shallow Depth Lots**

- Sizes: 40' to 55' WIDE + 60' to 85' DEEP (approximately)
- Opportunities:
  - Limited yard maintenance may be viewed as an advantage of these lots if buyers desire less maintenance.
- Challenges:
  - The shallow lot means that garages must be attached and even possibly "built in."
  - Unique layouts can be found that have been used in other cities for these situations, but zoning and building code considerations must still be followed.

**Standard Depth Lots**

- Sizes: 40' to 45' WIDE + 120' to 130' DEEP (approximately)
- Opportunities:
  - Standard lots offer some flexibility. The yards are of a size that is easier to maintain, but are large enough to support over-garage offices or carriage houses, if the builder chooses.

**Deep Lots**

- Sizes: 40' to 45' WIDE + 155' to 165' DEEP (approximately)
- Opportunities:
  - Deep lots allow for very creative solutions for multiple units within a single parcel. Examples of this from other cities and even small towns offer good reference material.
  - Deep lots allow the opportunity for those interested in very large yards to have them, creating choices in the neighborhood.
- Challenges:
  - More yard maintenance is associated with these lots.

**4.2.2 SETBACK LINES**

Certain setbacks lines are critical for neighborhood continuity and consistency.

In general, front yard setbacks should match the existing setback of adjacent housing, provided that housing does not break with the overall block continuity.

Garages should also match with existing setbacks in the rear, however, this could require a variance.

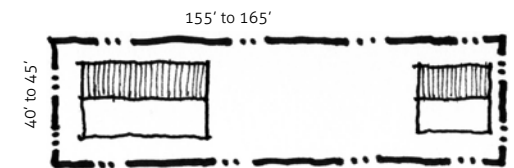
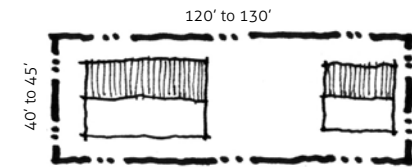
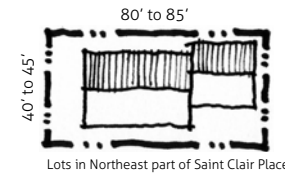
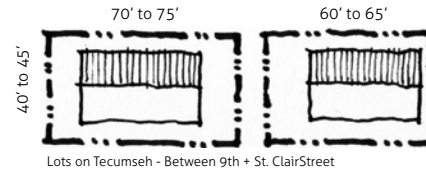
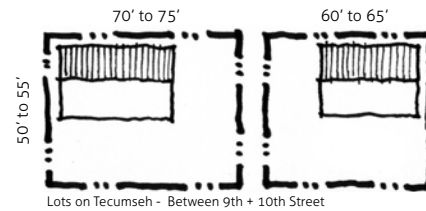

**Shallow Depth Lots** - There are a variety of different shallow lots. Each pose challenges to comfortably fit a garage.

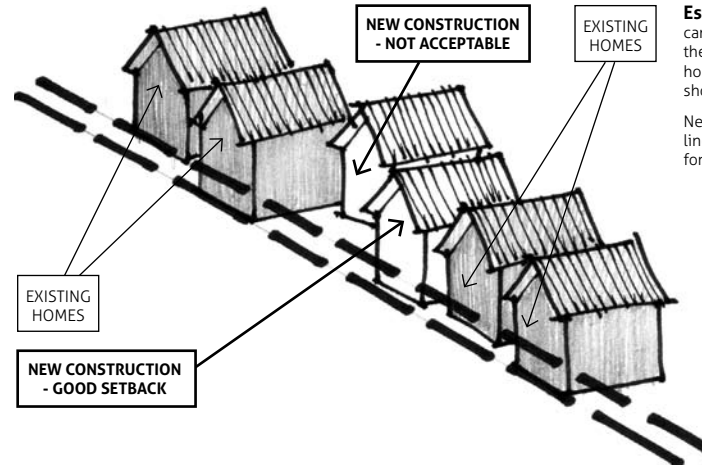

**Establishing the setback** - Two lines can be drawn from the closest house to the street and the one farthest away. Any houses with extremely different setbacks should be ignored.

New houses should fall between these two lines. This same exercise should be used for garages.

## 4.2 SITE LAYOUT

### 4.2.3 TYPOLOGIES

When multiple contiguous lots are under the control of one builder, different housing typologies will be possible for new construction.

#### Single Lots

- Single-family Home with Garage (attached or detached)
- Single-family Home with Garage and Carriage House above
- Duplexes with garage and/or Carriage House

#### Multiple Contiguous Lots

- Any combination of the above-mentioned types
- Townhomes or multi-family units. These conditions are separate from this pattern book and will likely require re-zoning consideration. These type of units are especially encouraged along 10th, Rural, and Michigan Streets.

### 4.2.4 ORIENTATION

A basic principle of this pattern book is that the primary elevations of houses should face the street. Each housing unit will have at least one "primary elevation" and some will also have a "secondary elevation".

Establishing the "primary elevation" of the house or housing unit depends on where the parcel is located within the pattern of streets and open spaces in the neighborhood.

#### Mid-Block

- Mid-block means that the parcel is sandwiched between two other parcels with houses on them.
- Mid-block housing should have one primary elevation which faces the street.

#### Corner Block

- Corner-block means the parcel is located at the intersection of two streets and has a neighboring parcel on only one side.
- Corner-block housing should have two important elevations – The "primary elevation" should face the dominant street and the "secondary elevation" can face the side street.

#### Adjacent to Open Space

- Adjacent to Open Space means the parcel has a neighboring parcel on one side and a park, farm, or other open or public space on the other side. Vacant Lots or private yards are not considered open space.
- Housing Adjacent to Open Space should have a "primary elevation" that faces the street and "secondary elevation" that faces the open space.

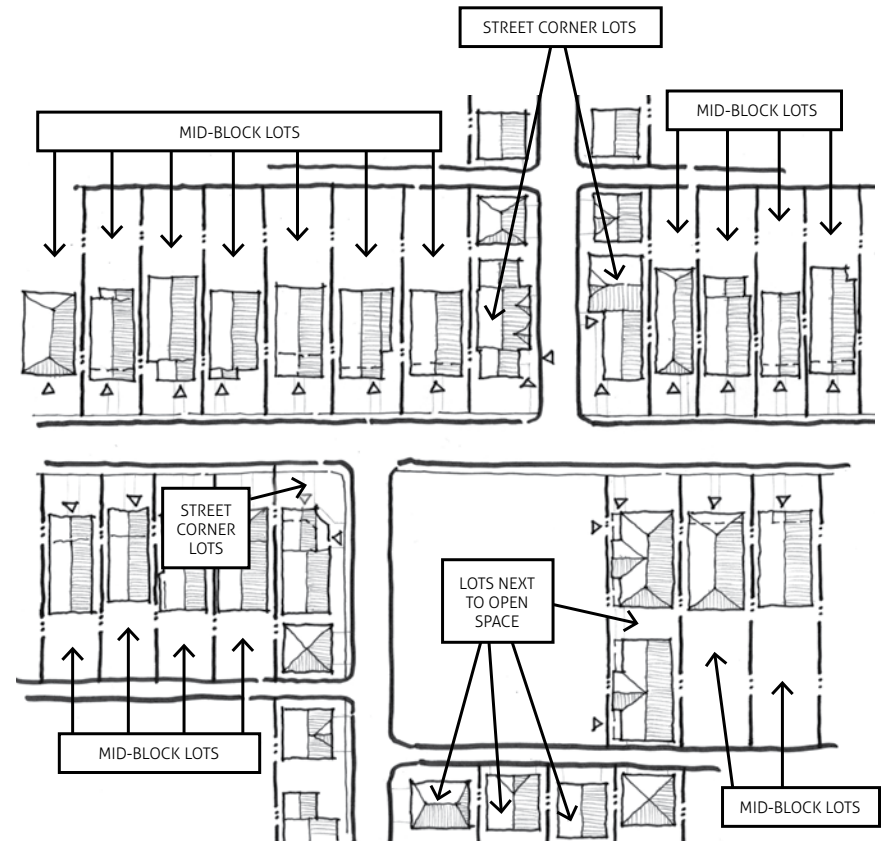

**4.2.5 MID-BLOCK HOUSING**

**Site Layout**

- ❑ Houses on these lots will have a singular “primary elevation”
- ❑ The primary elevation of the house should face the street and contain a front door along with a porch
- ❑ The garage should be set behind the house and be accessed from the alley, except for houses on the west side of Tecumseh, which do not have alley access.
- ❑ The sides of houses, as shown, should have windows.
- ❑ Garages for mid-block housing are not required to have windows, but it is encouraged, when buyers feel comfortable.

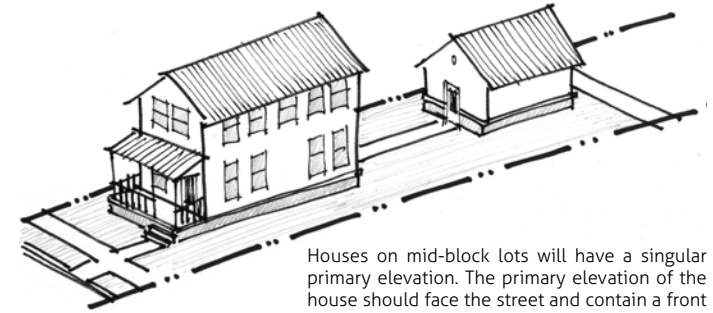

Houses on mid-block lots will have a singular primary elevation. The primary elevation of the house should face the street and contain a front door along with a porch.

**4.2.6 CORNER LOT HOUSING**

**Site Layout**

- ❑ Houses on these lots will have two “important elevations”. The “primary elevation” should face the main street and the “secondary elevation” should face the side street.
- ❑ The “primary elevation” of the house should contain a front door along with a porch.
- ❑ The “secondary elevation” should address the side street in one of the following ways:
  - ❑ A porch that wraps from the primary elevation of the house to the side, or
  - ❑ A projecting wing of a minimum of two feet with a gable facing the side street. The wing must have windows, or
  - ❑ A second entry door. This may be placed towards the rear of the open-space facing wall in lieu of the rear entry door for access from a detached garage. These doors should have a small overhang and entry steps.
- ❑ The garage should be set behind the house and be accessed from the alley.
- ❑ Garages are encouraged to have windows as they will be visible.
- ❑ A garage is shown here, but if an accessory dwelling unit (ADU) is built above, it should have windows which face the side street.

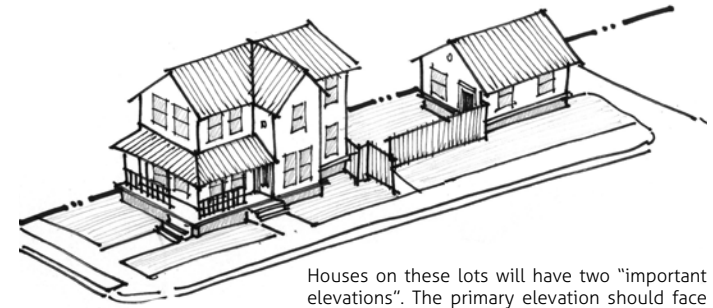

Houses on these lots will have two “important elevations”. The primary elevation should face the main street and the secondary elevation should face the side street.

**4.2.7 HOUSING NEXT TO OPEN SPACE**

**Site Layout**

- ❑ Houses on these lots will have two “important elevations.” The “primary elevation” should face the main street and the “secondary elevation” should face the open space.
- ❑ The “primary elevation” of the house should contain a front door along with a porch.
- ❑ The “secondary elevation” should address the open space in one of the following ways:
  - ❑ A porch that wraps from the street-facing front of the house to the side, or
  - ❑ A projecting wing of a minimum of two feet with a gable facing the open space. The wing must have windows.
- ❑ The garage should be set behind the house and be accessed from the alley.
- ❑ Garages are encouraged to have windows as they will be visible.
- ❑ An accessory dwelling unit (ADU) is shown here, but is not required. It is shown as an option only.
- ❑ It is suggested that rear yards facing open space be fenced so that park users can distinguish the private yard from the public park.



Houses on these lots will have two “important elevations”. The primary elevation should face the main street and the secondary elevation should face the side street. A carriage house is shown here but not required.

## 4.2 SITE LAYOUT

### 4.2.8 GARAGES + CARRIAGE HOUSES

**CARRIAGE HOUSE:** The term carriage house was originally used to refer to the area behind a home where horse-drawn carriages were stored. These have often been turned into accessory dwelling units and the name is now used for dwelling units above garages. Other terms such as coach house, mother-in-law quarters, and granny flat refer to these also.

- The highest point of the accessory unit should be less than the highest point of the main structure.
- Garages should be set back from the rear line consistently with existing faces of garages and accessory dwelling units (ADU) that face the alley. Current D-5 Zoning requires a deeper setback than the pattern book allows. Due to this situation, a blanket variance for this condition will be sought.
- All materials, siding, trim, door and window requirements that apply to main structures also apply to garages.
- Foundations of accessory units should match the primary unit in the height of the exposed foundation and in material.
- The roof pitch must either match the main structure or have a minimum 6:12 pitch.
- If a new garage is added onto or behind an existing structure, it should complement the existing structure in its roof pitch and massing
- In the instance of carriage houses, greater leniency is permitted in design vocabulary to allow for interesting decks, offices, and other features that will not negatively affect the block as viewed from the street.
  - Carriage houses are not addressed in zoning.
  - A majority of homes will not have carriage houses, therefore, a blanket variance for them is not being sought. Individual variances will need to be obtained for carriage houses and for re-zoning.
- Sheds, above ground pools, and other accessory structures are generally discouraged, unless they contribute to the appeal of the neighborhood by servicing food production or composting.

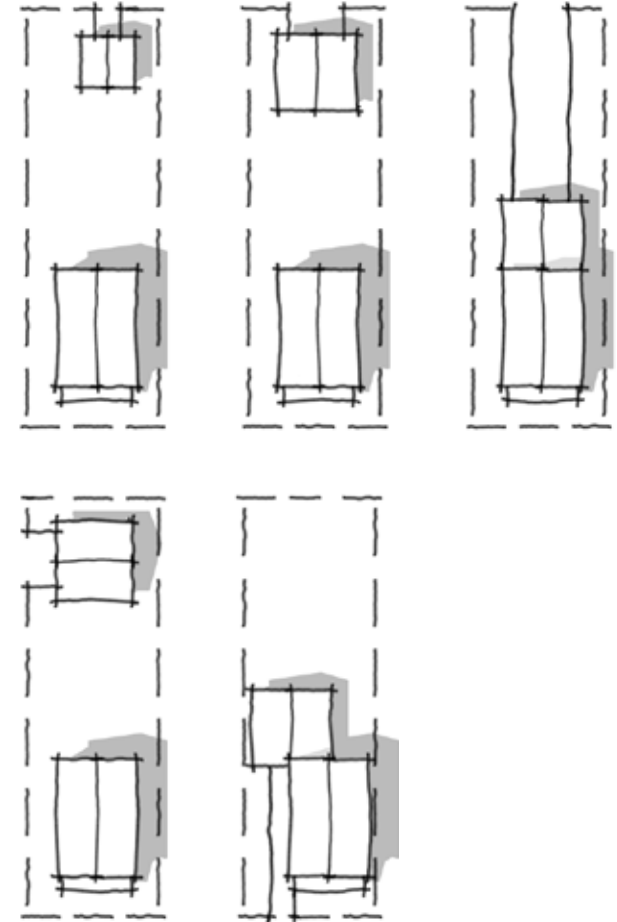

GARAGE AND CARRIAGE HOUSE LAYOUT OPTIONS. Regardless of the use of a garage or carriage house - there are many possibilities for their location, depending on the depth of the lot. Variations are shown above.

**4.3.1 INTRODUCTION**

FORM: The term “form” is used here as denoting the formal outline of a building’s mass or volume, excluding minor extensions and details. In this pattern book wings, porches and dormers are considered part of the basic formal massing of a building.

There are a variety of forms that exist in St. Clair Place. Many of the existing forms showcase the original quality of the homes. However, there are also houses that have undergone improper renovations and additions to the point of obscuring the original form of the structure.

For the basis of this pattern book, more detailed formal arrangements such as those that created the original housing, will not be mandated. The basic formal requirements within this pattern book are intended merely to ensure that new building forms fit contextually within that existing pattern.



Narrow-front houses work well on narrow lots to allow space for sidewalks on the sides.

L-shaped housing works well on wider lots and offers more variety in porch arrangement.

**4.3.2 MASSING - MAIN BODY + FOUNDATIONS**

**Narrow – front Housing**

- 1 to 2-1/2 stories are permitted
- Gabled, Hipped and Flat Roofs are permitted. However, Hipped Roofs must not be overly large without projections, such as a dormer

**L – Shaped Housing**

- 1 to 2-1/2 stories are permitted
- Combinations of Gabled, Side Gabled, and Hip Roofs are permitted, as are Flat Roofs.

**Exposed Foundations**

- There should be no slab-on-grade foundations
- The foundation height should be consistent with the foundations of adjacent houses. In general, first floors shall be set so that 16 to 24” of foundation is exposed.



There should be no slab-on-grade foundations. The foundation height should be consistent with the foundations of adjacent houses. In general, first floors shall be set so that 16 to 24” of foundation is exposed.

## 4.3 FORM

### 4.3.3 MASSING - WINGS, DORMERS, CHIMNEYS + PORCHES

#### Wings

- Wings to the sides or rear of buildings should be extended in a scale that fits well with the main body of the house.
- Wings should extend to the ground with the main body of the house. Projections which are three feet or less in depth, such as bay windows, do not require this.

#### Dormers

- Combinations of Gabled, Hipped, or Shed Dormers are permitted, however, the proportion of all enclosed or open dormers are to complement the proportions of the main body and have a complementary or consistent roof pitch with that of the main body.

#### Chimneys

- The width and height of the chimney should be in scale with the house.
- Chimneys must extend to the ground - they must not float from the building.
- PVC flues should be placed towards the rear of the roof and not visible from the street, when possible.

#### Porch Massing

- Porches should be built on every house's primary elevation
- Porches should run along at least a portion of the front of the housing unit.
- Porches should be at least 8-feet deep at their shallowest point to allow for comfortable seating and ease of passage.
- There must be a minimum of 120 square feet in total usable porch space. The intention of this requirement is to provide enough space for residents to be able to sit on the porch comfortably and observe the street.

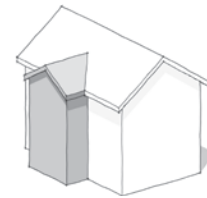

WINGS - partial option

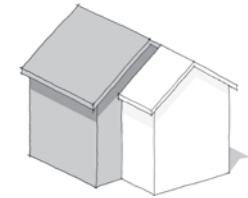

WINGS - large option

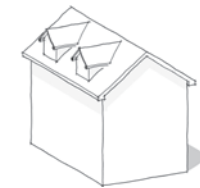

Dormer - Option A

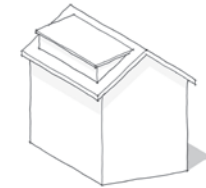

Dormer - Option B



Proportional Chimney



Not Proportional Chimney - notice the size is too narrow and thin. This is out of proportion.

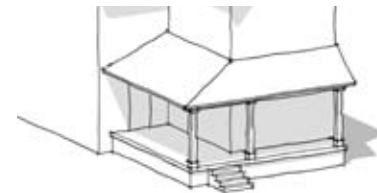

PORCH - wrap-around option

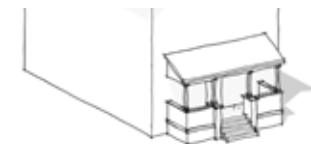

PORCH - front option

#### 4.3.4 ACCESSIBILITY MEASURES

Residents who have difficulties with mobility may need special design features to be able to access their home easily. This often includes a ramp that leads to the door for wheelchair access.

While many homes have been rehabilitated to include switchback ramps on the front of porches, these standards offer other solutions which could be less visually disruptive to existing neighborhood patterns.

##### Grading for Side Access via Sidewalks

- The site can be graded in many cases so that wheelchairs can access side doors with a flush landing.

##### Ramps on the side that enter the house

- If it is difficult to grade the sidewalk for wheelchair access, a ramp may also be used with minimal side rails for protection.

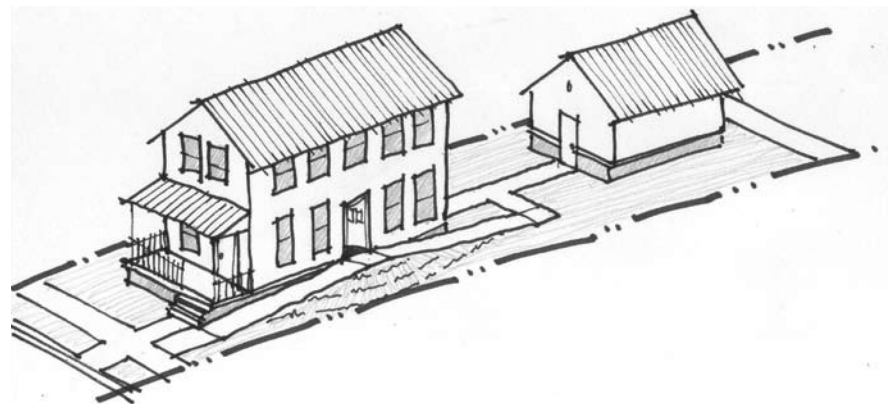

Notice that the ramp on the side of the house as shown can often be graded in such a way that walls and steps are not required.

## 4.3 FORM

### 4.3.5 PORCH STANDARDS

Porches are an integral part of Saint Clair Place and can be an important part of developing relationships with neighbors. Front porches can be seen as an extension of the home.

#### Overall Appearance

- Front porches should not be enclosed with windows or screens - they should be fully open to provide a welcoming gesture.
- Entry into the porch space should open at the location of the front door, maximizing ease of entry and exposure to the street.
- Porch detailing has a major impact on the way that a house appears from the street. Well designed and built porches and railing can make a major improvement in a house's appearance.

#### Porch Columns

- Porch columns should be spaced consistently so that the porch appears well designed and integrated into the design of the house.
- Porch posts should not be made up of exposed 4x4 or 6x6 lumber. These often crack and twist - and may appear unfinished as time passes.

#### Porch Railing

- Railing can be beneficial in some cases, but is not required on front porches.
- Porch railing should not be built in a rear-deck like manner. The porch pickets should not overlap the front face of the rails.
- Added detail on porch railing can add interest.

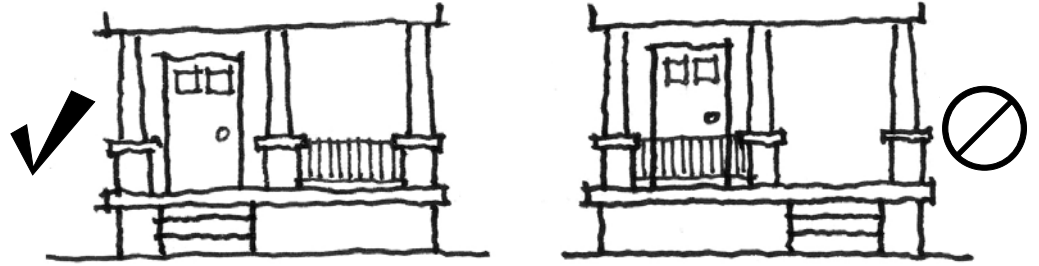

Entry into the porch space should open at the location of the front door, maximizing ease of entry and exposure to the street.



Exposed 4x4 or 6x6 lumber should not be used for porch posts. These often crack and twist - and may appear unfinished as time passes. The post on the left is very clean in appearance, while the post on the right is cracked.



Railing can be beneficial in some cases, but is not required on front porches.



Porch railing should not be built in a rear-deck like manner. The porch pickets should not overlap the front face of the rails.



Added detail on porch railing can add interest.



Added detail on porch railing can add interest.



**4.3.6 EAVES + GABLE EXTENSIONS**

**Eaves**

Eaves must extend at least 16"

**Gables**

Gables must extend at least 12"

NOTE: No bird box detailing will be allowed.

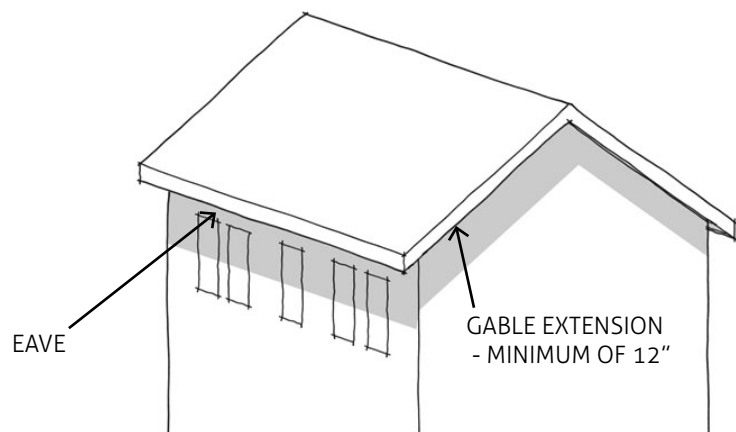

NOTE: The Shadows on the image are meant to indicate the purpose of the eave and gable extension requirements. The shadow helps to define the cap of the house while functionally keeping downpouring rain from harming the houses siding.

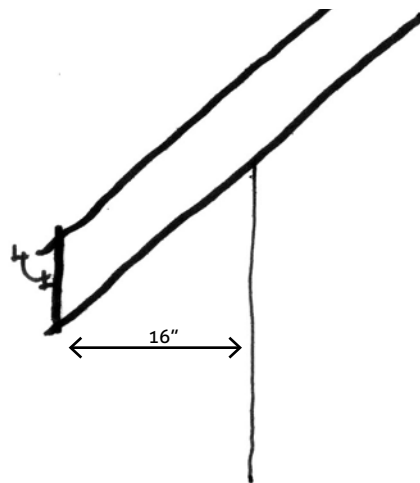

Exposed, sloping soffits are acceptable. Bead board roof sheathing / soffit material is preferred.

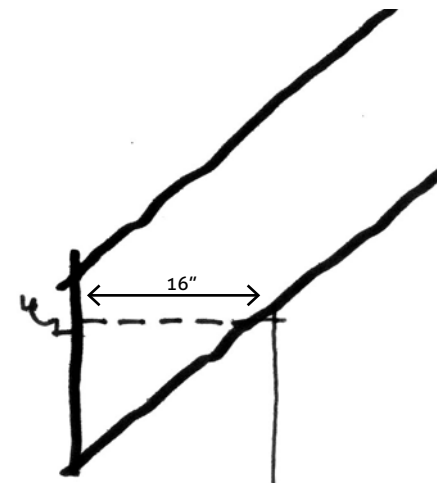

Flat soffits can be hidden behind an extra tall rake board.

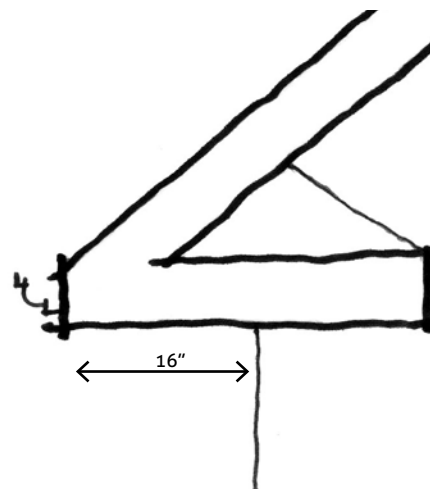

Rake / Fascia returns allow for flat soffits

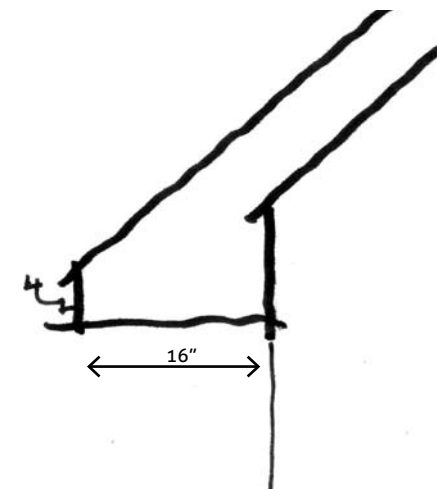

"Bird Box" gable rakes, as shown above, should be avoided

## 4.4 WINDOWS, DOORS + VENTS

### 4.4.1 COMPOSITION OF WINDOWS, DOORS + VENTS ON WALLS

Many pattern books go into more detail about the compositional arrangement of windows and doors on each particular elevation of a building that would coincide with established and understood styles. This pattern book, however, only recommends a few basic compositional guidelines.

#### Basic Compositional Guidelines

##### Window Placement

- Windows should be arranged in balance across each floor, not consolidated in only one area.
- There should be no “blank walls” where there is a general lack of windows.
- First story: A minimum of two windows per wall is required.
- Second story: A minimum of two windows per wall is required if the second story spans more than 2/3 the length of the first story. Only one window is required if the second story spans less than 2/3 the length of the first story.
- Windows should line up on each story so that no window is shown floating between floors, with an exception for walls with stair landings. Stairs should not be located on the elevation which faces a street or open space. Steps to make these situations balance are encouraged.
- For more dynamic window patterns that create a unique style, cases will need to be reviewed.

##### Doors

- Doors should be arranged to provide a balanced appearance with the window arrangement

##### Vents

- Any vents on dormers and attics or gable vents should be centered along the wall with another element such as a window or door.



The image on the left shows a house with plenty of windows - and the doors and windows are composed to make a strong appearance. The image on the right shows too much space on the upper left floor with no window. This would require more detailing on the facade than is currently shown.

**4.4.2 WINDOWS**

- ❑ Windows shall be vertical in proportion. Exceptions will be made for rows of clerestory windows along a bedroom or living room walls.
- ❑ No snap in place, or between pane grids are permitted.
- ❑ Windows, in general, should utilize trim:
  - ❑ Minimum of 6" head (casing)
  - ❑ Minimum 4" casing
  - ❑ Minimum 2" skirt
- ❑ Glass-block should be avoided, with an exception for basement windows within foundations.

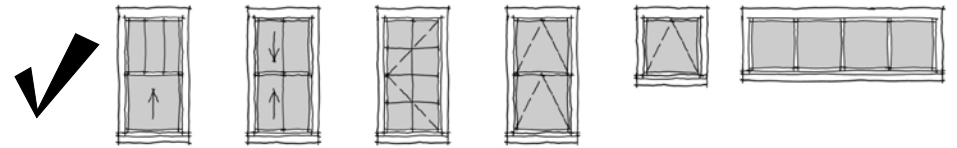

COMPLIANT WINDOWS. This list of windows and dividers are commonly found in Saint Clair Place and are acceptable..

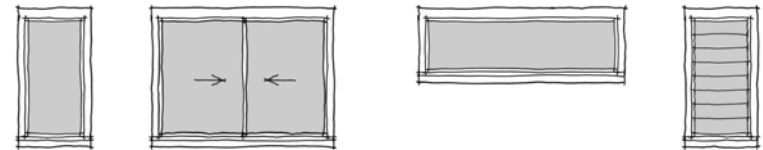

POSSIBLY-COMPLIANT WINDOWS. This list of windows come from housing styles such as ranches and newer styles which are inconsistent with the types in Saint Clair Place. However, they can be incorporated into new construction to allow for casements - especially for modern stylistic choices.

**4.4.3 DOORS**

Doors are encouraged to make a significant gesture to the street. They are one of the most important features of a home.

- ❑ It is encouraged that reused salvage front doors be used.
- ❑ It is encouraged that doors on "important elevations" should incorporate windows and double barrel locks.
- ❑ In cases where buyers feel more comfortable with windowless doors, they will be permitted, but they should incorporate knockers to avoid the fortress effect.
- ❑ Doors should not be detailed in a way or made of materials that do not complement the neighborhoods character.
- ❑ Transoms are encouraged. This may require a 9-foot ceiling height.

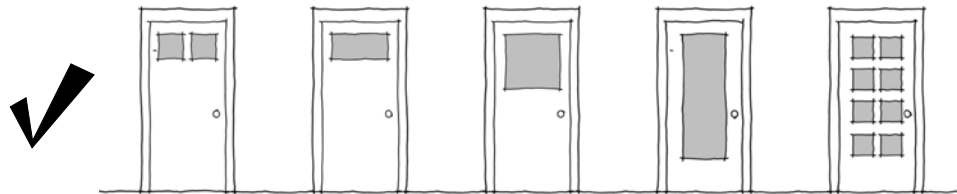

COMPLIANT FRONT DOORS. This list of doors and the shapes of their inserts are often found on existing homes and are acceptable.

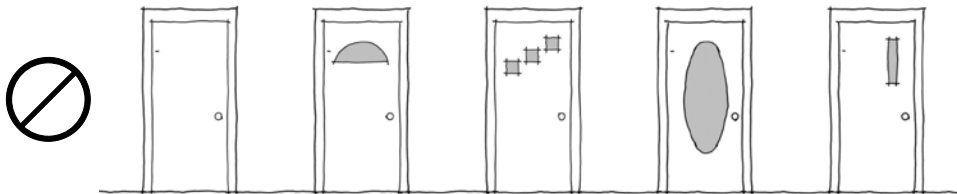

NON-COMPLIANT FRONT DOORS. This list of doors and the shapes come from housing styles such as ranches and newer styles which are inconsistent with the types in Saint Clair Place.

## 4.5 EXPOSED FUNCTIONAL ITEMS

### 4.5.1 FLUES

- Exposed metallic flues should be placed to the rear of the home. All vents must be plumb.
- Flues should not be painted as this can later chip.

### 4.5.2 DOWNSPOUTS

- Downspouts should not be installed along the front face of the home, particularly along porch columns.

### 4.5.3 LIGHTS

- Lights should be provided for all porches and off of garages facing alleys.
- Lights on the porch should be either on the wall, next to the front door, facing the street or be ceiling mounted.
- No bright brass or lacquered brass fixtures will be permitted. Fixtures should be made of durable metal materials that will not easily dent or be damaged.
- Lights on garages should be located over the door or in the center of the elevation of garages with multiple doors facing the alley



Flues should be plumb.



Flues should not be painted as this can later chip.



Downspouts should be placed to the sides, not at the front.



This downspout should not be placed in front of the porch column.



Fixtures should be durable and not made of bright shiny brass as shown.

### 4.6.1 SIDING

- Vinyl siding is generally discouraged.
- If proposed, vinyl must be smooth, not stamped with false wood-grain or other textures.
- Dutch lap siding is not permitted.
- Cementitious siding is to be smooth, not patterned.
- The maximum exposure for all horizontal siding is 6"

### 4.6.2 TRIM

NOTE: Trim is to be sensitively handled as it often gives a great sense of character to traditional housing units.

- Corner trim must be a minimum of 3-1/2" wide
- Trim is to be smooth, not rough-sawn
- Trim must be primed on all surfaces + painted
- Trim should be either Cedar, Composite, or Engineered Wood. No SPF, Framing Lumber, or Poplar is permitted for trim.
- When vinyl siding is used as the surface material - trim boards should be built out to allow vinyl siding to tuck behind trim boards.

NOTE: This essentially requires that windows/doors/corners be trimmed twice - once with a "filler board" that the J-channel butts into, then once with a finish trim board that overlaps the J. The filler board cannot be OSB or another synthetic product and it needs to be flashed properly to ensure durability.

### 4.6.3 COLORS

- A minimum of two colors is to be used on exterior elevations (an additional complementary or contrasting color should be used on doors and important details).
- Highly detailed units may exceed three colors for detailing purposes.
- Final color choices must be approved.



Dutch lap vinyl is not permitted.

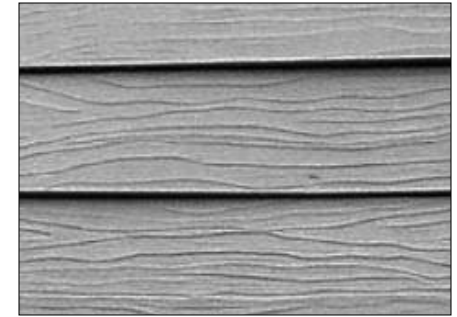

Patterned or wood grain vinyl is not permitted.



J-channels should be tucked behind trim pieces.

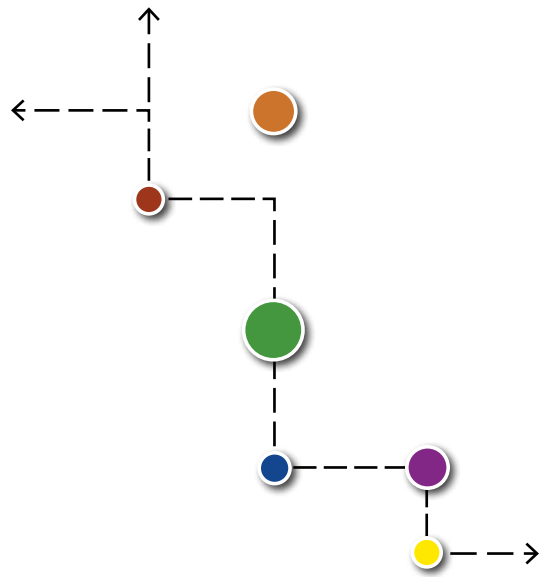

# Saint Clair Place

Housing Construction and Rehabilitation

Pattern Book

## Chapter 5.0 Landscape Standards

### 5.1 INTRODUCTION

Standards for landscape focus mainly on plant selection and placement as well as showing locations for the various fence and wall types often seen in neighborhoods.

The goal for these standards is to be light and allow flexibility while avoiding common pitfalls that often are found in neighborhoods.



## 5.2 LANDSCAPE STANDARDS

### 5.2.1 PLANTING STANDARDS

- A shade tree from a list on record with IAD must be planted to block afternoon sun, with the intent of reducing energy expenditures.
- Shade trees, when planted in front yards, should be provided between the sidewalk and the porch. Exceptions will be made for front yards which benefit from a shade tree provided within a tree lawn space.
- Evergreen screens and sculpted ornamental trees should not be used in front yards.
- When ornamental trees are desired, it is recommended that they come from the list on record, so as not to create safety or visibility problems.
- It is important to pay attention to the specific variety of species, so as not to purchase landscape items that require significant maintenance, have habitual disease problems, or cause potential hazards for nearby structures.
- The use of native, non-invasive plant material is encouraged to reduce watering and maintenance requirements.

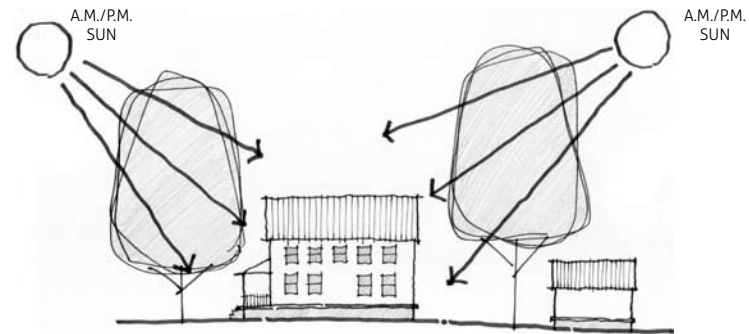

Using shade trees with a large mature height are effective tools for shading windows and roofs, reducing air-conditioning needs in the summer.

### 5.2.2 ACCEPTABLE PLANTS LIST

#### SHADE TREES

- |   |  |
|---|--|
| <input type="checkbox"/> OAKS - Red + Pin     | <input type="checkbox"/> LONDON PLANE  |
| <input type="checkbox"/> MAPLES - Red + Sugar | <input type="checkbox"/> FRONTIER ELM  |
| <input type="checkbox"/> TULIP TREE           | <input type="checkbox"/> GINKGO BILOBA |
| <input type="checkbox"/> BALD CYPRESS         |  |

#### ORNAMENTAL TREES

- SERVICEBERRY
- DOGWOODS - Cherokee Princess, Kosuga
- REDBUD
- HAWTHORNES - Winter King + Washington

#### SHRUBS

- |   |   |
|---|---|
| <input type="checkbox"/> VIBURNUMS - dentatum + acerifolium     | <input type="checkbox"/> SWEETSPIRE             |
| <input type="checkbox"/> HYDRANGEAS - Oakleaf, Bigleaf + Wild   | <input type="checkbox"/> RED + BLACK CHOKEBERRY |
| <input type="checkbox"/> WINTERBERRY - Mix Male + Female Evenly | <input type="checkbox"/> BAYBERRY               |

#### PERENNIALS

- |  |   |
|--|---|
| <input type="checkbox"/> YARROW                        | <input type="checkbox"/> SWEETSPIRE             |
| <input type="checkbox"/> JOE PYE WEED                  | <input type="checkbox"/> RED + BLACK CHOKEBERRY |
| <input type="checkbox"/> SEDUM                         | <input type="checkbox"/> BAYBERRY               |
| <input type="checkbox"/> CONEFLOWER + BLACK-EYED SUSAN |   |
| <input type="checkbox"/> MAIDENHAIR GRASS              |   |
| <input type="checkbox"/> BLAZING STAR                  |   |

\*This list is not binding - for native species - see: [www.plantnative.org](http://www.plantnative.org), or consult local nurseries

\*For plants to absolutely avoid: <http://extension.entm.purdue.edu/CAPS/browseDistribution.html>

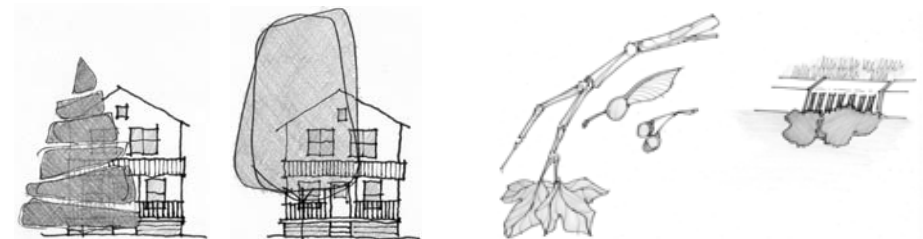

Shade trees work better in front yards than evergreens because the branches start higher off the ground and are easier to see the fronts of houses.

The plant list attempt to avoid species that lose too many limbs, seed in large numbers, or drop too much fruit. This can cause maintenance headaches and litter can collect in and clog sewer grates.

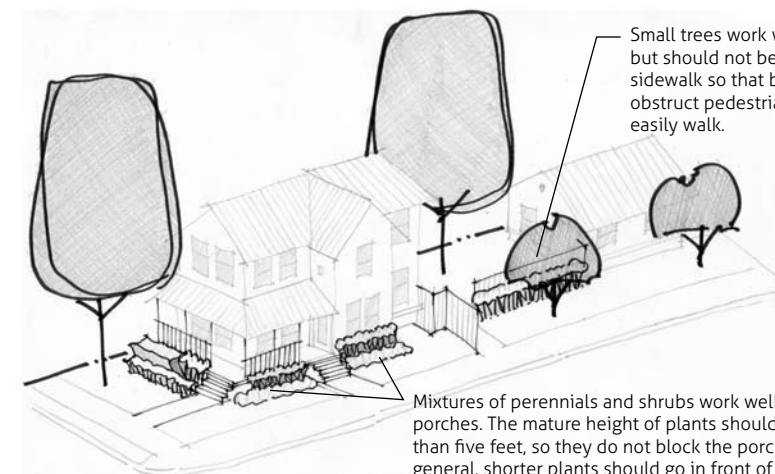

Mixtures of perennials and shrubs work well in front of porches. The mature height of plants should not reach more than five feet, so they do not block the porch or windows. In general, shorter plants should go in front of taller ones.



5.2.3 FENCING STANDARDS

- Chain-link fencing is not permitted under zoning code Special regulations Sec. 731-221. (f)(1)(a + b)) in front yards.
- Front fencing must not completely screen the yard – there must be regular openings.
- Fencing should not exceed a height of 42". Picket fences typically range in size from 30" – 42."
- Rear-yard privacy fencing should not come past the mid-point of the side elevations of the housing unit unless it conforms to front fencing regulations.

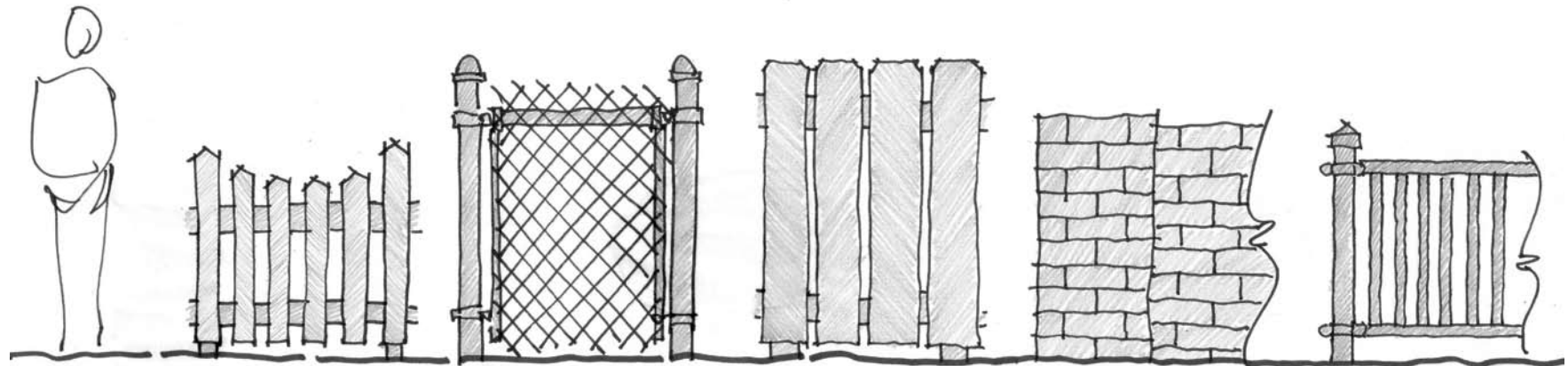

**Picket Fences**  
 These are acceptable in any part of the yard. In front yards, it is encouraged that picket spacing allow for an open view of the front yard or garden. The height is not to exceed 42 inches in the front yard.

**Chain-link Fences**  
 These are acceptable in rear yards only. They should not be placed any where closer to the front yard than the mid-point of the side of the house. For houses on street corners, chain-link should not be used on the side facing the street.

**Wood Privacy Fences**  
 These are acceptable in rear yards only. They should not be placed closer to the front yard than the mid-point of the side of the house. There are many design options for wood fencing. Dog-ear is shown here only as one option.

**Block or Brick Walls**  
 Brick walls can have visibility and safety issues and should only be used in situations where the yard requires a wall due to the slope of the yard.

**Ornamental Metal Fencing**  
 These are acceptable in any part of the yard. Gates should not be used to block pedestrian access to the front door or mailbox. The height is not to exceed 42 inches in the front yard.

# Saint Clair Place

Housing Construction and Rehabilitation  
Pattern Book

